

Air curtain: Aris



INSTALLATION, OPERATION AND MAINTENANCE MANUAL



Please, read these instructions carefully before attempting installation

SAFETY WARNING SYMBOLS



Attention, Danger, Safety Advice!



Danger from electric current or high voltage!



Injuries risk!



Danger! Do not stay underneath: Heavy load.



Important information.

INDEX

CAUTIONS	4
INSTALLATION	5
TRANSPORTATION AND STORAGE	12
OPERATING INSTRUCTIONS.....	12
WIRING DIAGRAMS	23
DATASHEET.....	26
MAINTENANCE INSTRUCTIONS	28
REPAIRS AND REPLACEMENTS	32
TROUBLESHOOTING	37
DECLARATION OF CONFORMITY	40
IDENTIFICATOR	42
GUARANTEE	42

CAUTIONS

IMPORTANT INSTRUCTIONS

Please before installing or using the air curtain, read carefully all instructions and considerations to reduce the risk of fire, electric shock, injury to people or damage to the air curtain itself. For that is recommended to follow the next basic precautions:

1. Use the air curtain only in the manner intended by the manufacturer and described in this manual. Any other use not recommended may increase the risks mentioned before.
2. Installation work and electrical wiring must be done by a qualified technician. Be also careful to not damage electrical wiring or hidden utilities when cutting or drilling into a wall or ceiling.
3. The air curtain is a heavy appliance and for that matter it must be elevated with proper lifting tools to prevent injuries to the people who install it.
4. Before servicing or cleaning the unit, switch power off at service pannel and lock the service disconnecting the means to prevent being switched on accidentally. When the service protection elements cannot be locked, securely fasten a prominent warning device, such as a tag, to the service panel.
5. It's HIGHLY recommended to do a periodical maintenance as stated in this manual section following the instructions given to clean the inlet grille, visual inspect each part and prevent any possible malfunction or issue of the air curtain before it happens.
6. Do not operate any air curtain after it malfunctions. Disconnect power at service panel and have air curtain inspected by a qualified technician before reusing.
7. To disconnect the air curtain, turn the control "OFF", wait 10 minutes for the device to stop completely and then turn off power supply to the air curtain.
8. The air curtains with heating are hot when in use. To avoid burns, do not let bare skin touch hot surfaces. Keep combustible materials, such as furniture, pillows, bedding, papers, clothes, etc at least 3cm (1 inch) from the top, back, front, sides and at least 180cm (6 feet) from the discharge of the air curtain.
9. To prevent a fire, do not block the air intake or discharge of the air curtain in any manner. Also prevent any foreign objects to enter any ventilation or exhaust opening as it may cause an electric shock, fire or damage the air curtain.
10. The air curtain has hot and may have arcing or sparking parts inside. Do not use it in areas where gasoline, paint or flammable vapors or liquids are used or stored.
11. Extreme caution is necessary when any air curtain is used by or near children, elderly or invalids, and whenever the air curtain is left operating unattended.
12. Some air curtain may include a visual alarm to warn that parts of the air curtain are getting excessively hot. If the overheating alarm is active because inside the temperature is rising too much, then the air curtain protects itself changing the functioning by increasing ventilation speeds and/or reducing heating stages. Check Troubleshooting part in this manual for more info about how to proceed.
13. Air curtains must not be installed outdoors unless is intended for outdoor use. If so, the air curtain should be always protected against rain and it's recommended a special protection to prevent corrosion and other issues caused by the environment (optional).
14. In case of vertical air curtains, these MUST be installed in a leveled floor for optimal performance and prevention of accidents.
15. The optimal working temperature of the fans is between 5°C and 40°C (41°F to 104°F) to protect the electrical components and at most should not exceed 50°C (122°F).

SAVE THESE INSTRUCTIONS

INSTALLATION

Tips and recommendations for a good installation

LENGTH

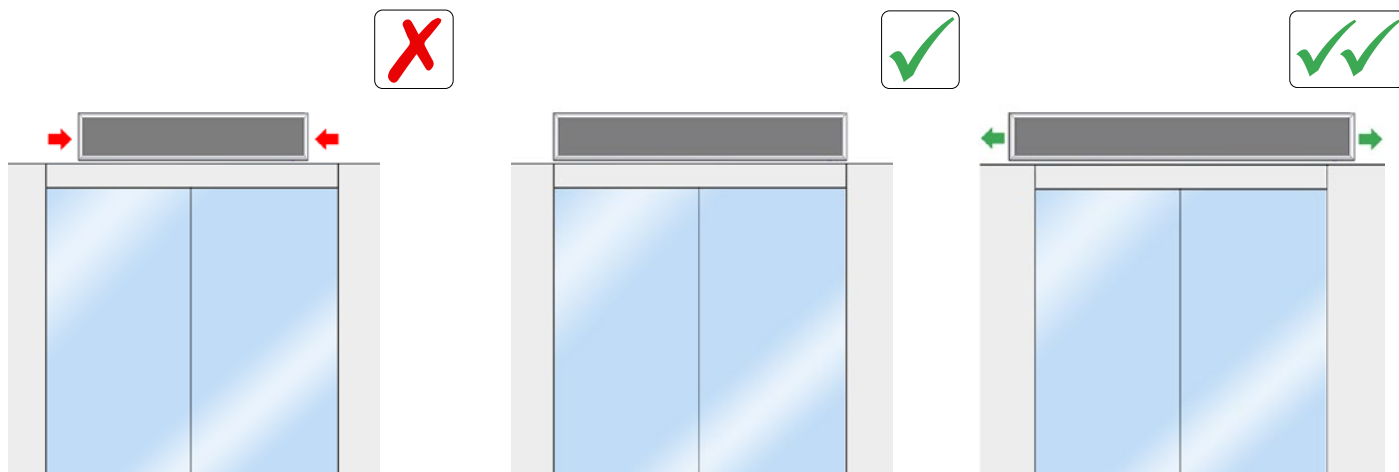

CENTERED / HEIGHT

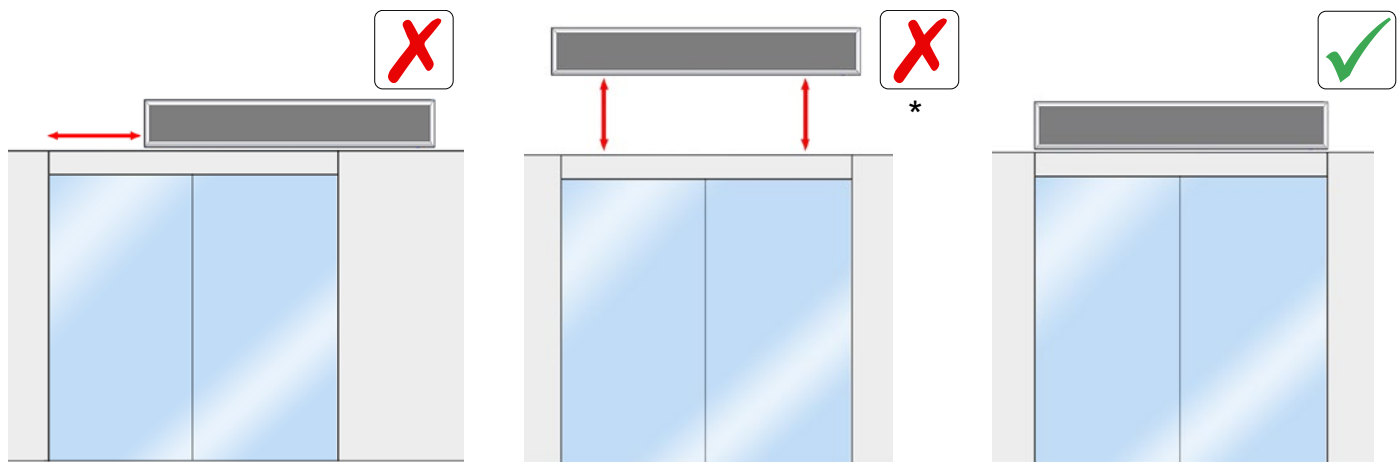

(* Unless it has been designed to be installed at that height.

DOOR DISTANCE

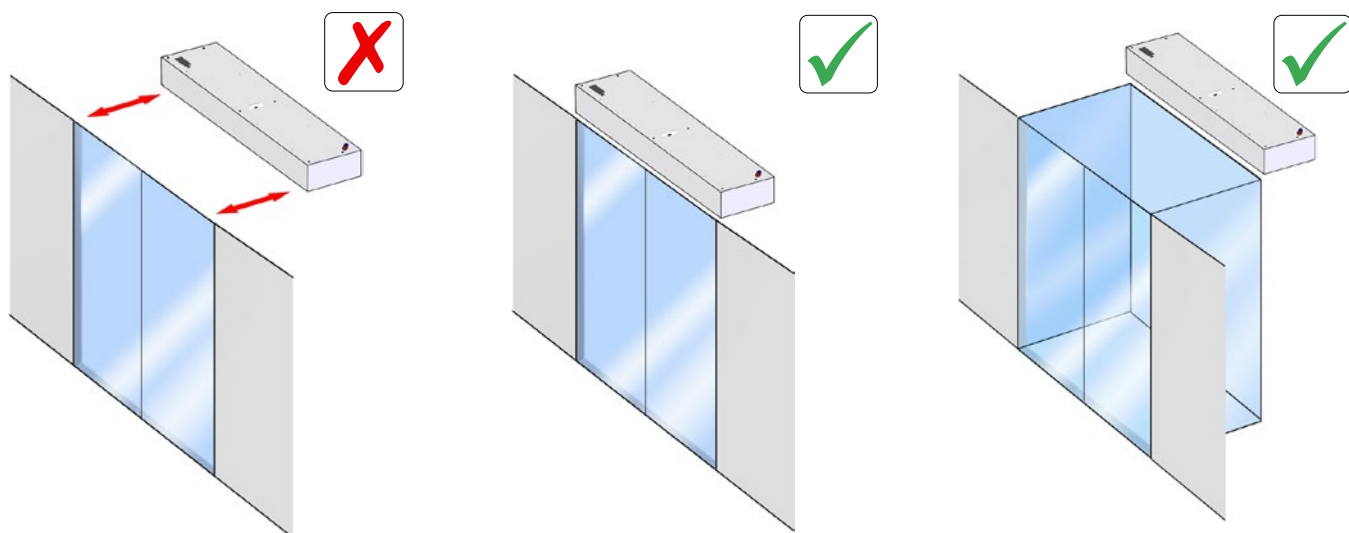

AIR DISCHARGE

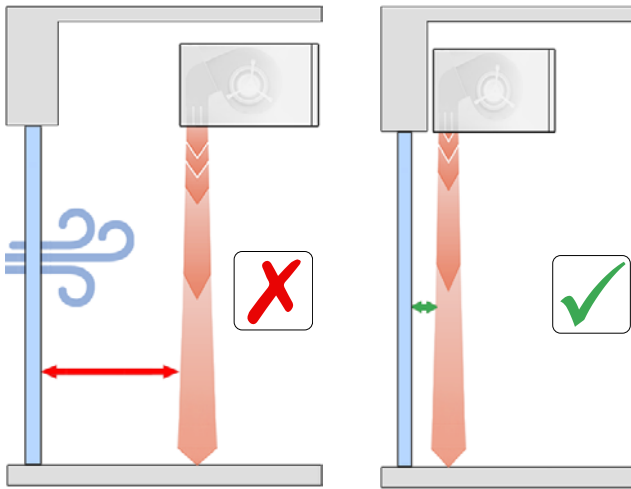



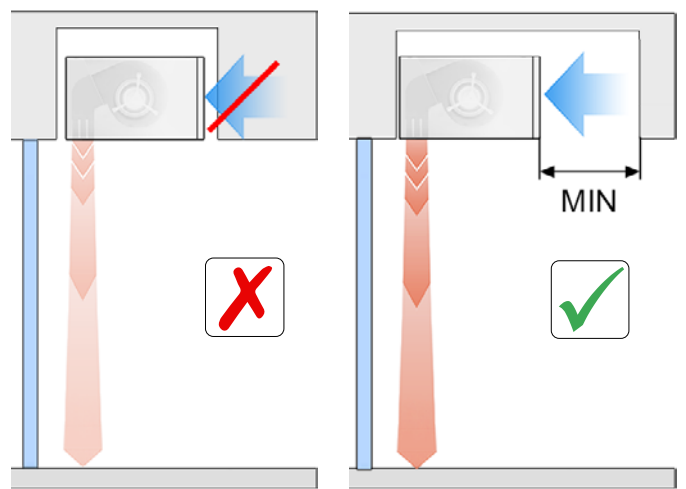

AIR ASPIRATION

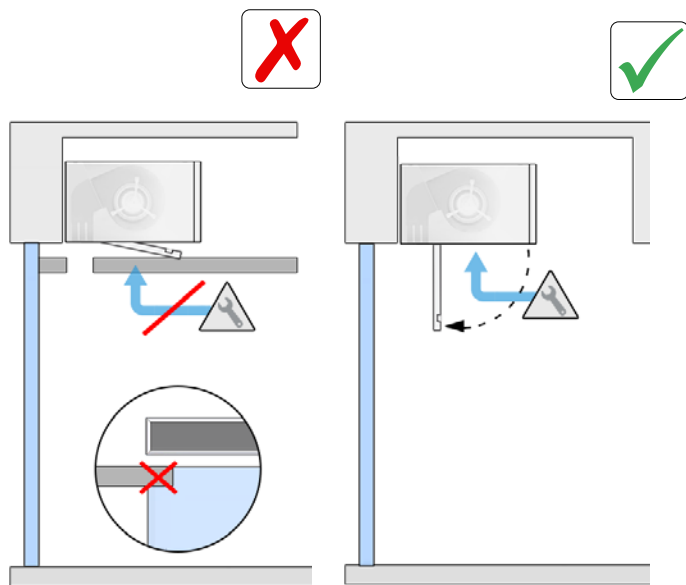

MAINTENANCE ACCESSIBILITY



Aris model

	<p>Installation work, connection, disconnection, electrical wiring, maintenance and service must be done by qualified people observing these instructions and in accordance with all applicable norms and standards. If the unit is operated with additional controller, please consider its specific instructions.</p>
	<p>For manipulation safety, being it assembling, transport or maintenance duties it's a must to wear the correct individual protection equipment recommended. Those being gloves, insulating shoes, goggles and helmet.</p>
	<p>There is no need to open the service door to connect the air curtain. All connections of power supply, control, water pipes (when the model is a water heated) and fixations are external. They are placed on top of the units. Depending of the model, inside of them may be auxiliar connectors like temperature sensors, electrovalves, etc.</p>
	<p>For safety, the air curtains never have to be stopped by disconnecting them from the main supply, always through the controller and waiting 10 minutes at least to disconnect the main supply. In case to not follow these instructions, the internal parts of the air curtain can be damaged.</p>

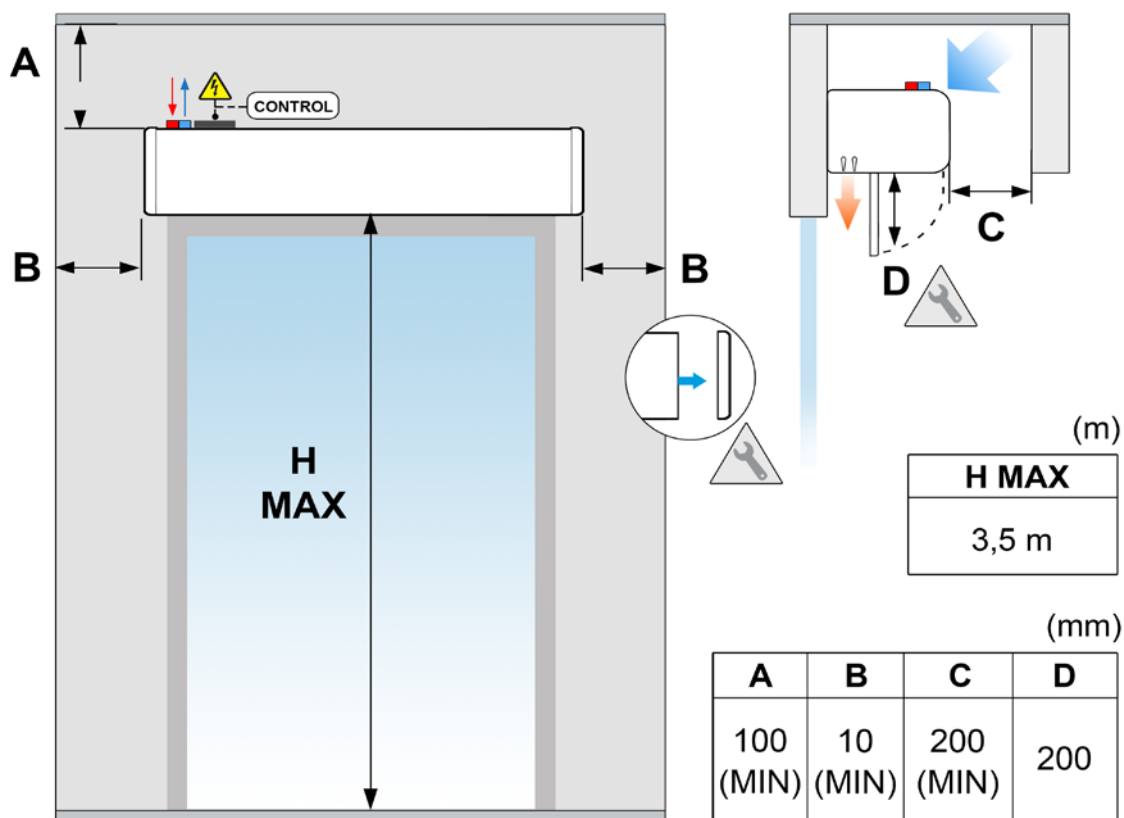

H MAX. Maximum recommended range, MIN. Recommended minimum distance.

The minimum recommended distance between the suction grille and any obstacle is 200 mm (Dimension C)

Dimension D: service opening distance.

Standard electrical heating 400Vx3 and 220-240Vx1

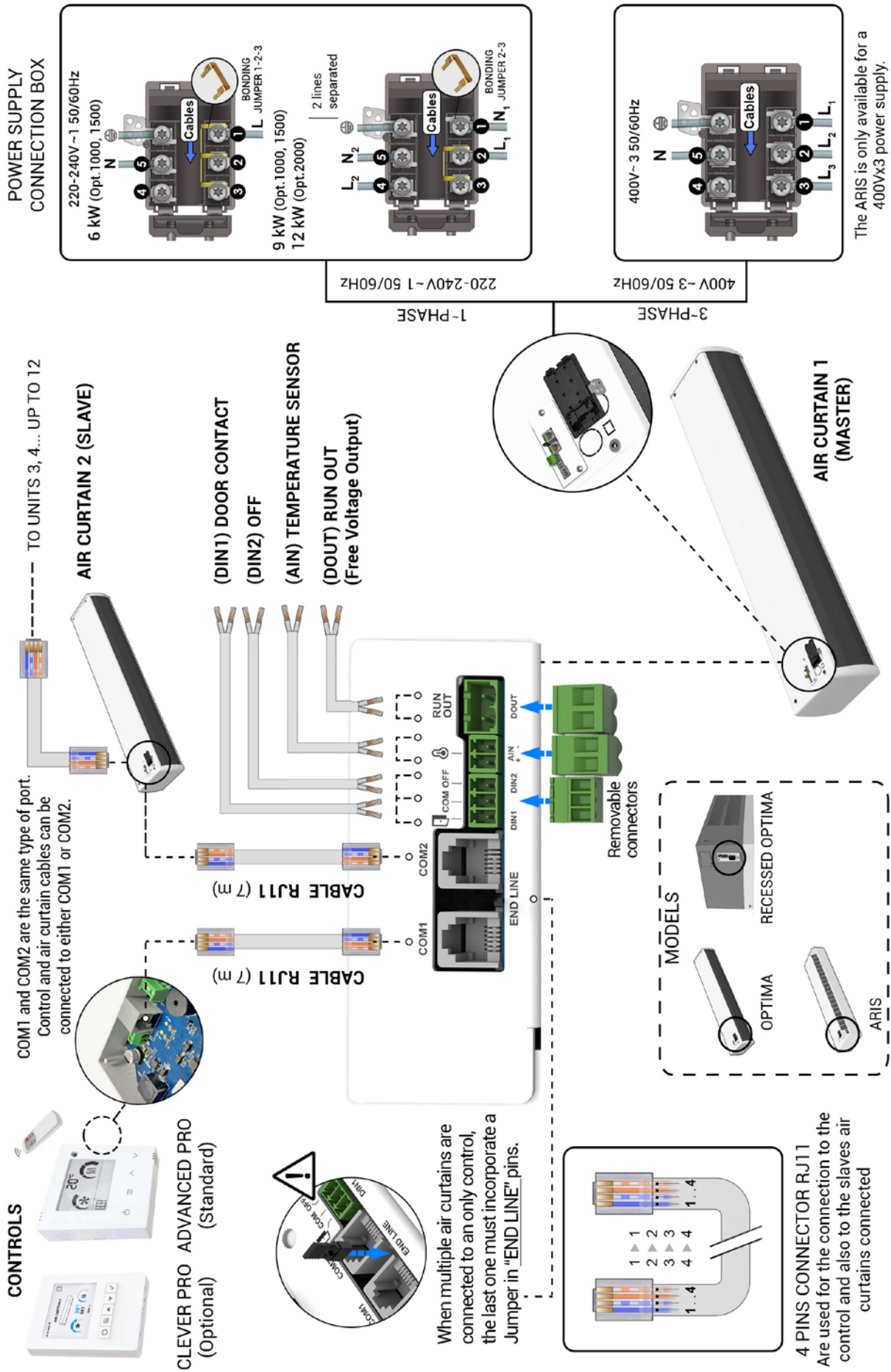

Power supply

To supply the device, the connection should be done at the top exterior part of the air curtain:



Water heated and non heated models:

The air curtain only must be connected to single-phase current at 220-240V for the operation of the fans directly to the PCB using the IEC connector supplied (see connection Diagram).

Electrical heated models:

Only connect a 400Vx3 three-phase power supply (see connection Diagram). Other voltages available on request.

The maximum number recommended of air curtains connected to the same differential (30mA or 300mA indifferently) is 20 units.

Each installation must be checked by a specialist to verify that there is no incompatibility between the selected electrical protections and the connected air curtains.

Control

To connect the control to the air curtain, there are terminals (COM1 or COM2) located on the outside top of the air curtain. It is not necessary to open the air curtain to connect it, except for internal connections. Use the 7 meter RJ11 cable supplied with the equipment and connect one side to the control and the other to COM1 or COM2 in the air curtain. The communication between the controller and the board is modbus.



Fixings

The air curtain has several external fastening points depending on the weight and length (see situation in the model characteristics section).

Generally, air curtains are installed horizontally. For vertical installation, use the feet kit (see datasheet section to see accessories). The anchor must be sized according to the weights of each air curtain indicated on the technical data page. The installation can be done using threaded rods, tensioners or other supports (see available supports in the accessories section).

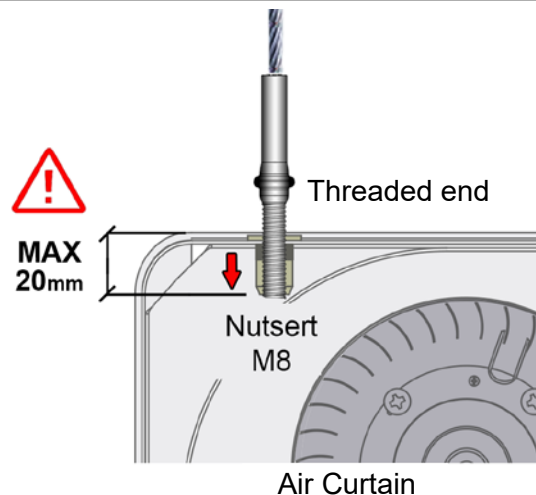

Water heating

The air curtains with water heating have a 220-240Vx1 output to optionally connect an ON/OFF valve (it opens or closes the water inlet to the heat exchanger). This output can also be used for other low amperage electrical appliances (4A).

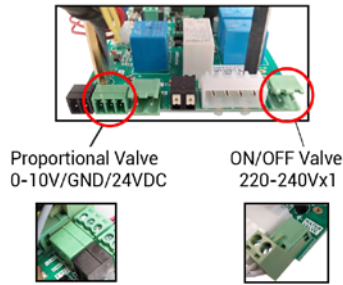

It also includes 24V and 0-10V output for proportional valves (see connection Diagram).

Recommendations:

- Close the hot water flow (valve) to avoid overheating of the motors while the equipment is off. Optionally, Airtècnics offers solenoid and proportional valves.
- In the installation of the building, two shut-off valves (in and out) should be provided to be able to disassemble the equipment without problems.
- Mount a bleeding valve at the highest point of the heating section.

The ambient temperature must always be higher than +4° C. The air curtain has an internal security that actuates when the room temperature decreases below 5°C.

The water coils have a drain screw in the collector area to empty the water in case of maintenance (see repairs and replacements sections).

Electric heating

The electric battery has three or six bar-shaped resistances (depending on the model) that, combined with each other, provide three heating stages. The regulation is carried out by one or two PRBEO (depending on the model) up to 18kW included.

All the batteries are electrically and electronically protected against overheating.

During the first uses, the electric battery can give off some odor that disappears in a few days.

According to battery power, the regulation is carried out by:



Size of the air curtain	Heater power (kW)	Regulation type
1000	9	1 PRBEO
1500	12	2 PRBEO
2000	18	2 PRBEO

TRANSPORTATION AND STORAGE



Warning! Heavy load.
Do not stand under the suspended load during transportation or assembly.

Store in a dry place protected from the environment. If the package is opened, cover the air curtain to protect it from the dust. Do not step on or place heavy loads on it to avoid damage to the material. Storage temperature between -20 °C and +40 °C.

When transporting the material, be sure to use the recommended tools to move and lift heavy parts to prevent injuries or damages. Also you must ensure that it is not damaged by the forklift. (possible penetration of the fork in the packaging). Observe the instructions on the packaging for correct manipulation of the product.



OPERATING INSTRUCTIONS



For safety, the air curtains must never be stopped by disconnecting the current, always do it through the control. If the power is turned off to turn off the air curtain, or within ten minutes of turning it off with the control, internal components may be damaged.

Characteristics of regulation boards

The air speed is regulated by the connection of the capacitor to the motor.
All PCBs have different inputs to add three additional temperature sensor (AIN, TEMP1 and TEMP2). The kind of sensor that must be used is: NTC B3950 10K at 25°C.

LCD Control ADVANCED PRO

The **ADVANCED PRO** control is a versatile Plug&Play controller for air curtains, compatible with all models of:

- 2 or 5 ventilation speed
- Types of heating: unheated, water heated, electrical heated and direct expansion (DX).

Once connected, it detects the hardware, and configures itself automatically according to the air curtain model (ventilation speed and type of heating).

The **ADVANCED PRO** control adjusts the heating based on the desired set temperature, depending on the room temperature and the outside temperature (if an additional sensor is installed).

In addition, it allows to select different speeds and heating stages depending on the state of the door. It has a "Boost" function that to ensure comfort, increases the heating when the door is open.

The main features of the control are the next:

- Backlight LCD indicating fan speed, heating stage, room temperature, door state, external control, auto cooling, alarms and errors.
- Inbuild room thermostat to turn ON/OFF or modulate the heating according to set temperature.
- Ready for door contact with door delay to allow 2 different ventilation speed and heating stages depending on door state (open/close).
- 3 digital IN configured according to the program (ON/OFF external, ON/OFF heating, fire alarm, etc).
- Allows configuration of maximum limit of fan speed and heating when door is open and closed, the boost mode, the memory, etc.
- Filter/maintenance alarm by time.

Screen and Button Layout:

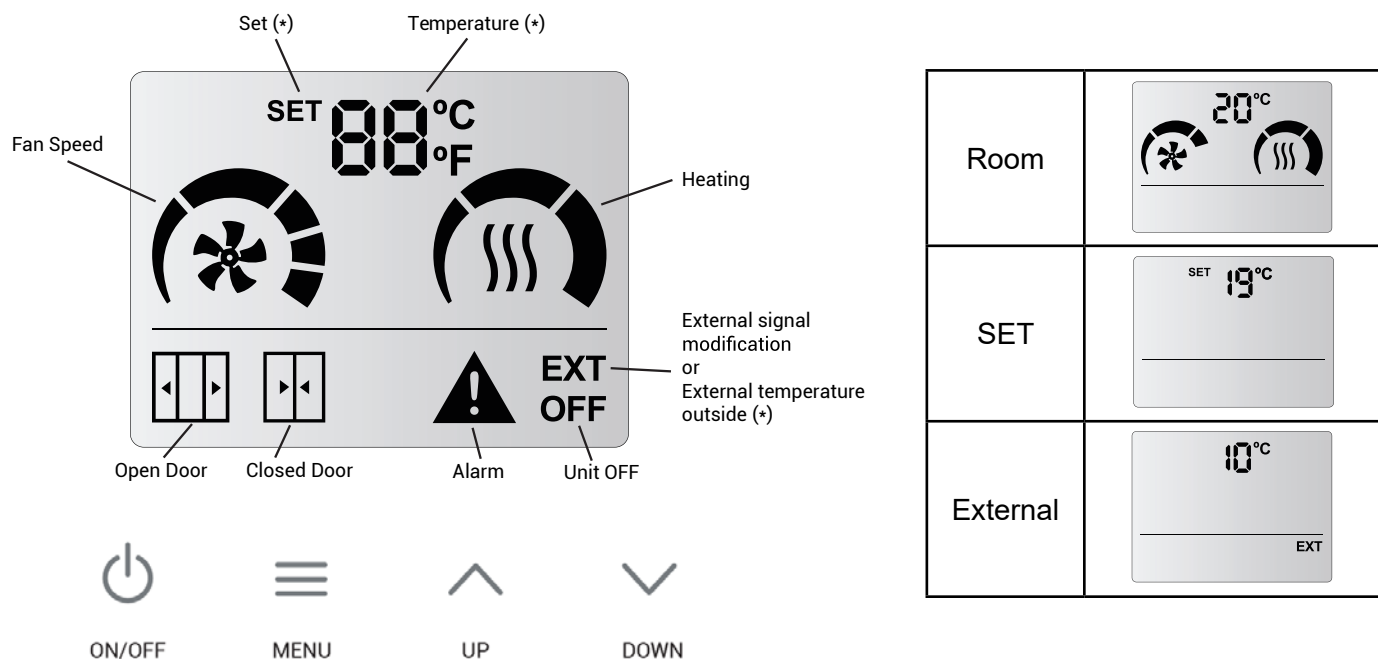

- ON/OFF (circle with line)
- Set temperature (arrows)
- User Menu to configure the functioning (3 lines):
 - Door open and door close ventilation speed.
 - Door open and door close heating stage.
 - Set temperature

User Functioning:

The display will know what functional limits exists and will only show the parameters that we can modify.

- **Temperature SET:** the desired temperature can be set between 10°C and 35°C. Below 10°C and above 35°C, you can select “no” and the heating will not be limited by temperature (manual mode).
- **Fan Speed:** user can select one fan speed for open and another for closed door. If the speed is set to 0 then the unit will be off.
- **Heating:** it depends on the air curtain model:
 - *Only Air:* It has no heating.
 - *Electrical heated:* the user can select between 0 and 3 heating stages depending on open and closed door and the fan speed selected.
 - *Water heated:* a single stage (ON/OFF) can be selected depending on open and closed door. If it has a proportional valve it can be regulated on 3 stages.

Device Initialization

When the control is plugged into the power supply, the screen will show the firmware version, the program the equipment is working on and will scan the number of air curtains connected.

Example:

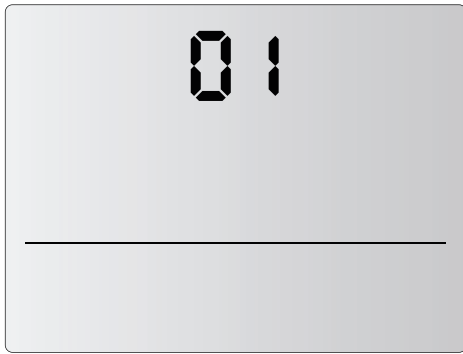

ADVANCED PRO version: 01

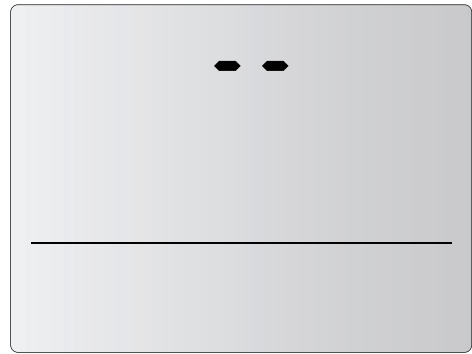
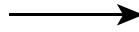

Space between version and subversion.

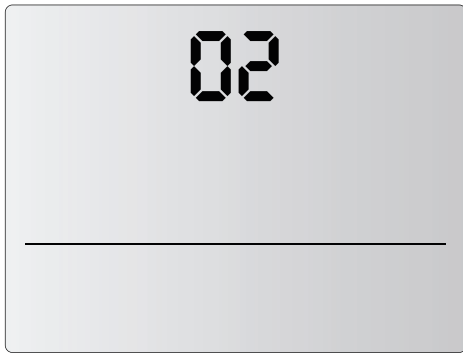

ADVANCED PRO subversion: 02

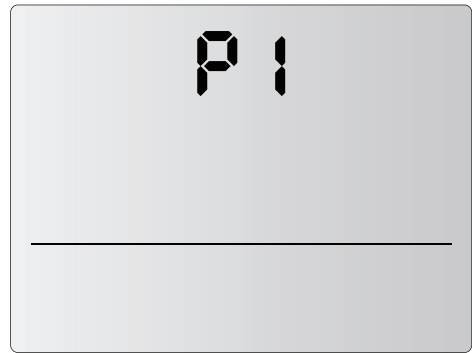

Unit Working in P1.

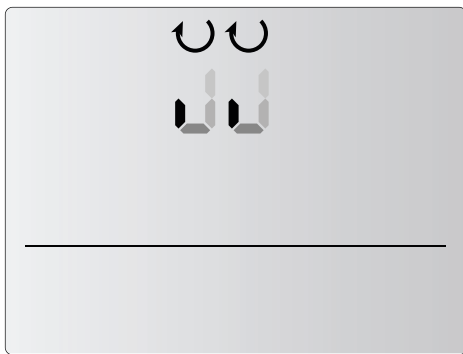

Scanning units.

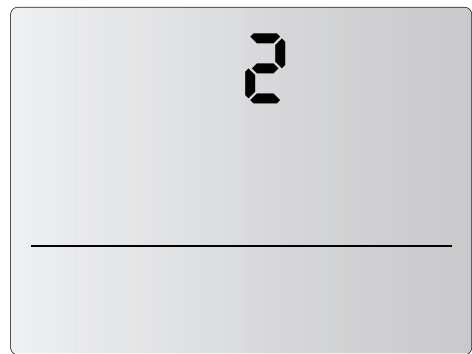
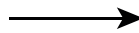

2 units connected to the control
(last number shown during initialization)

LCD User Menu Flow

Menu Flow for Only Air (Non-heated) models:

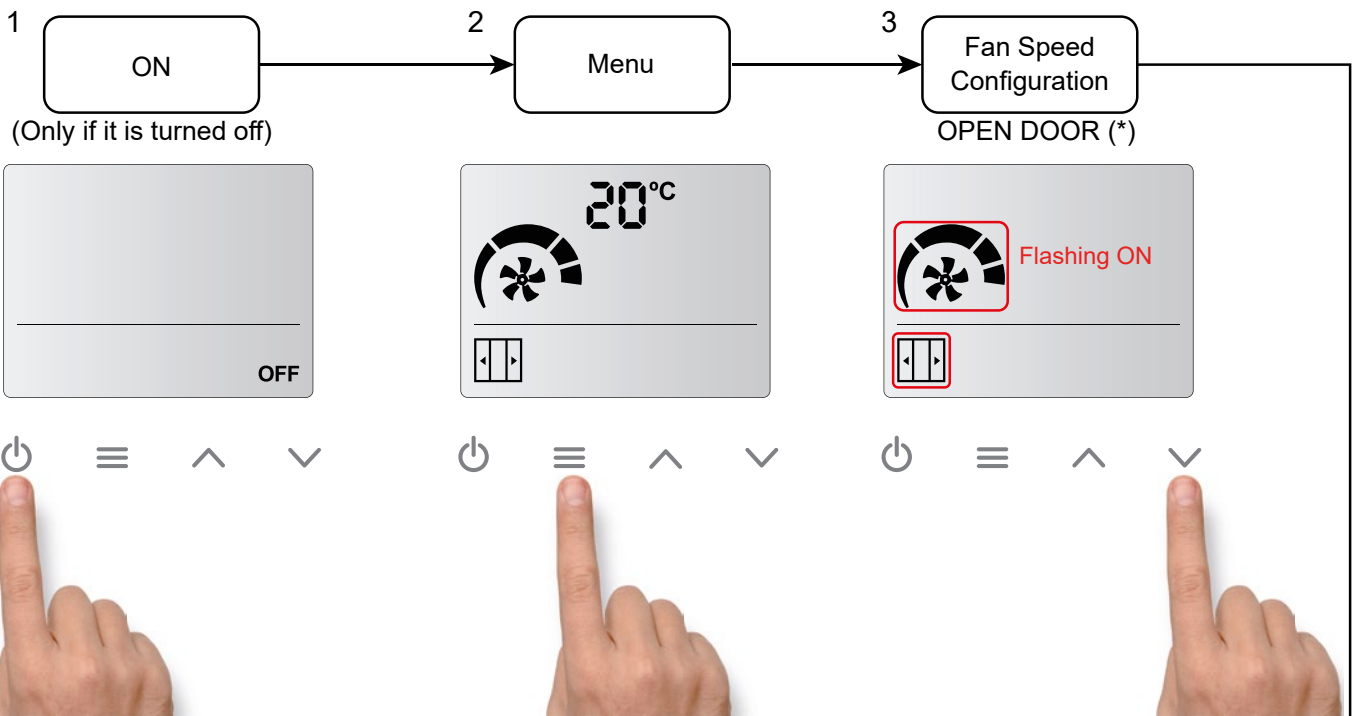

When turn on the unit or power supply is restored: if memory is ON, it will return to the configuration it had before turn off or external incident (power supply fail).

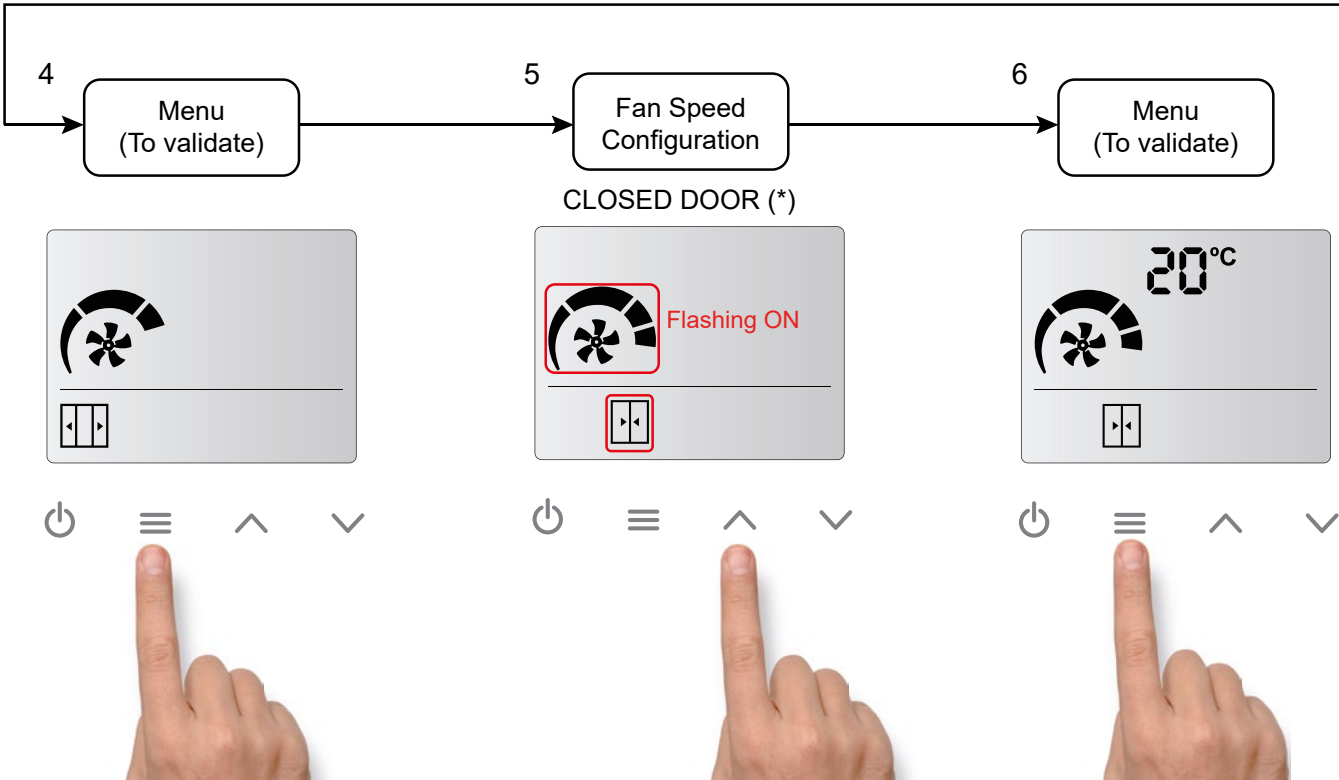

(*) If the door contact is not detected, the door open and door closed icons will not appear. Only one speed and one heating will be available.

Menu Flow for heated air curtains models (it's the same process for electric heated, water heated or heat pump units):

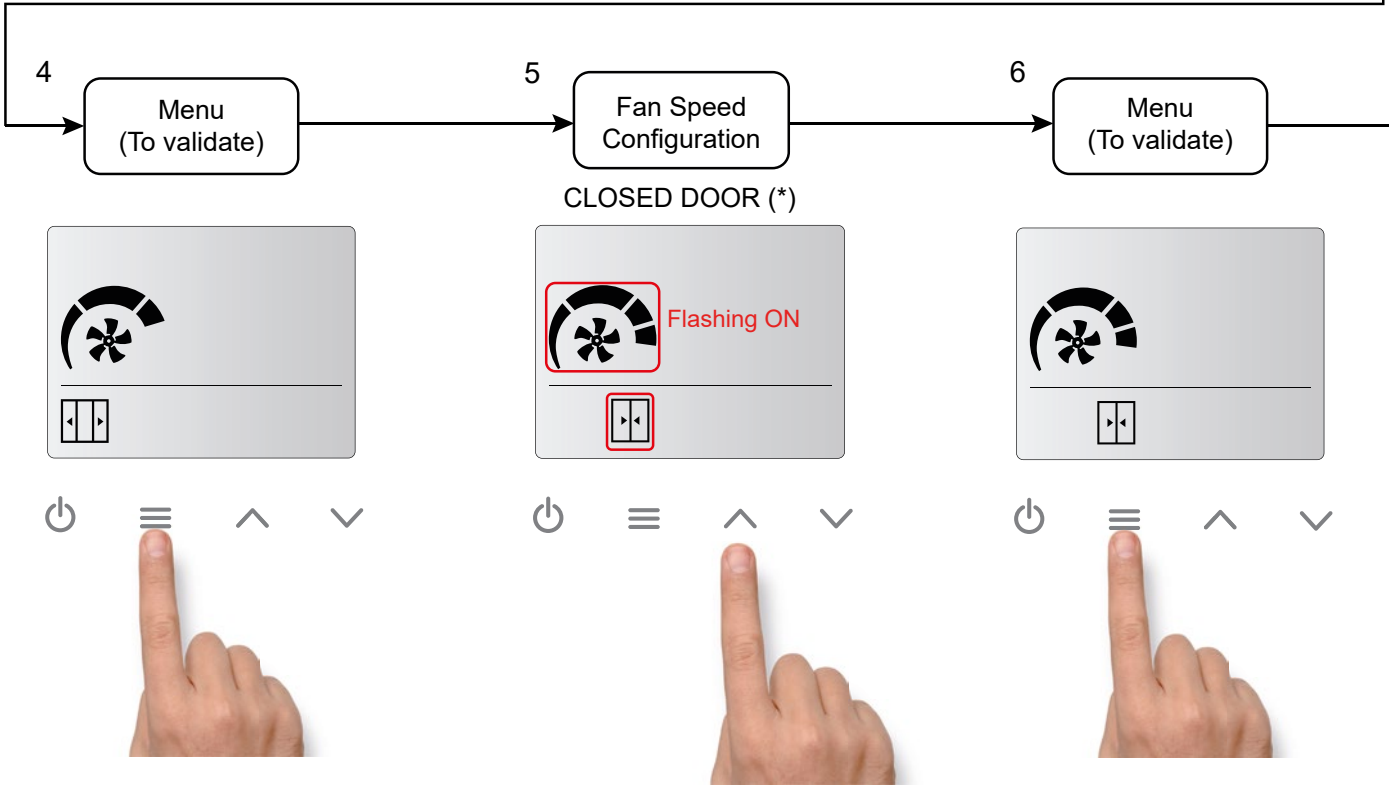
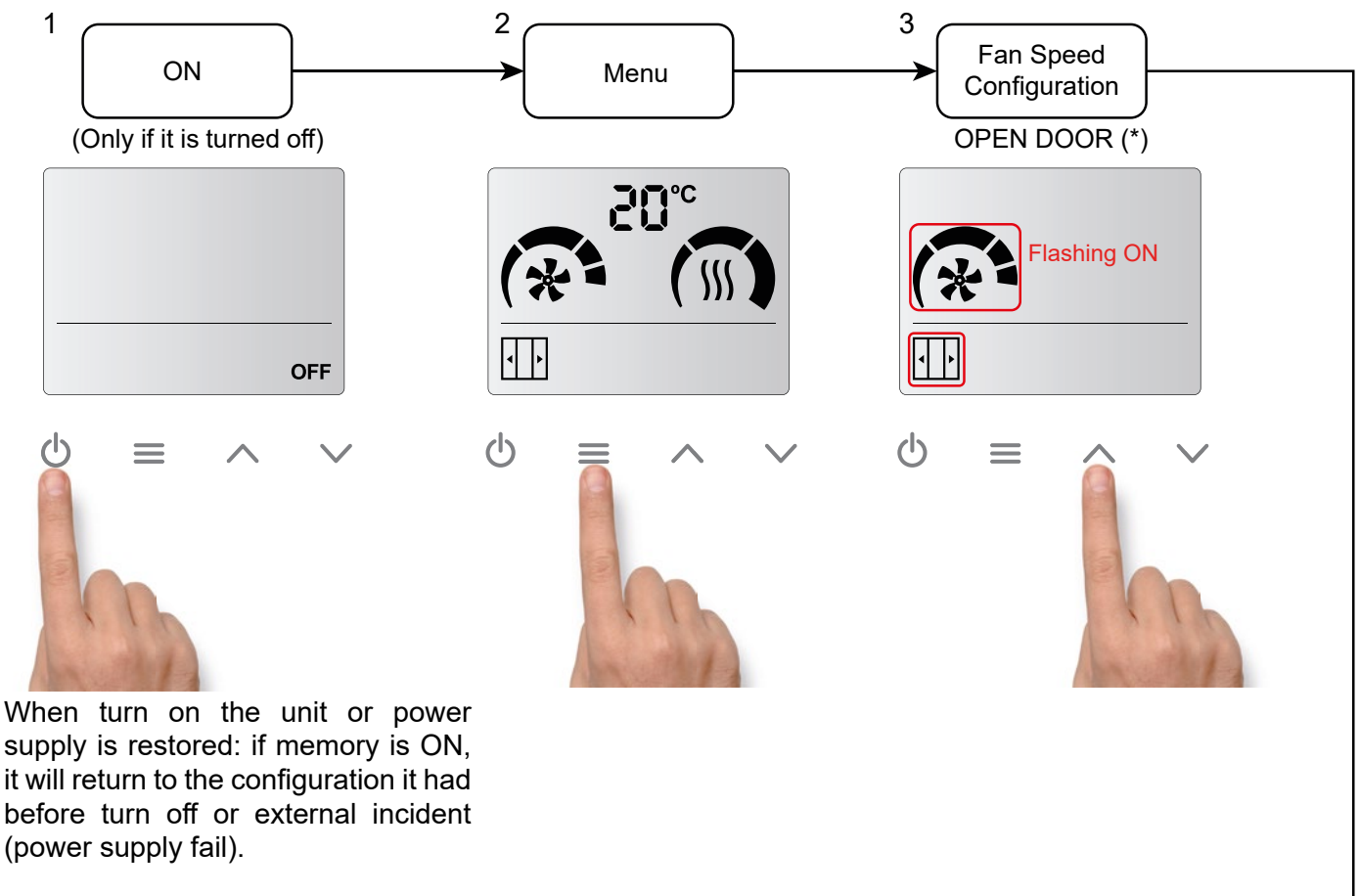

(*) If the door contact is not detected, the door open and door closed icons will not appear. Only one speed and one heating will be available.

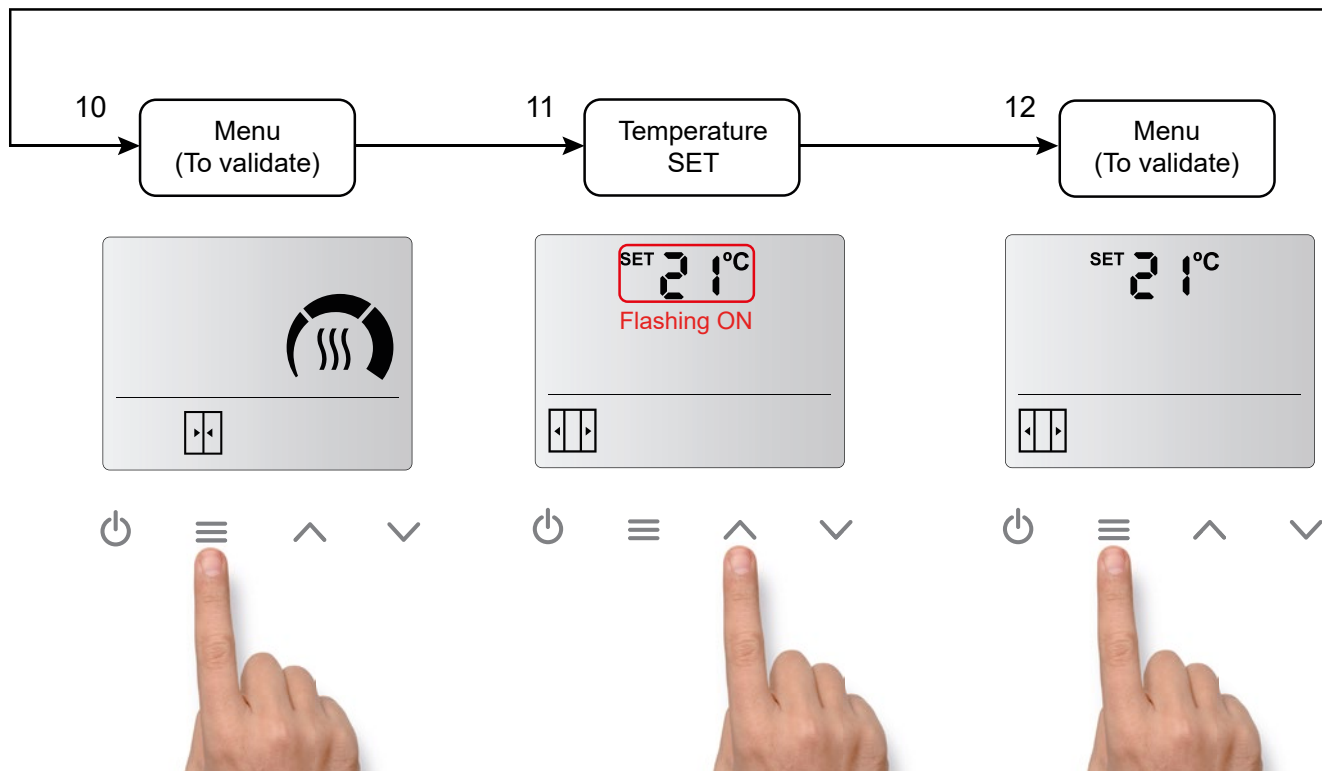
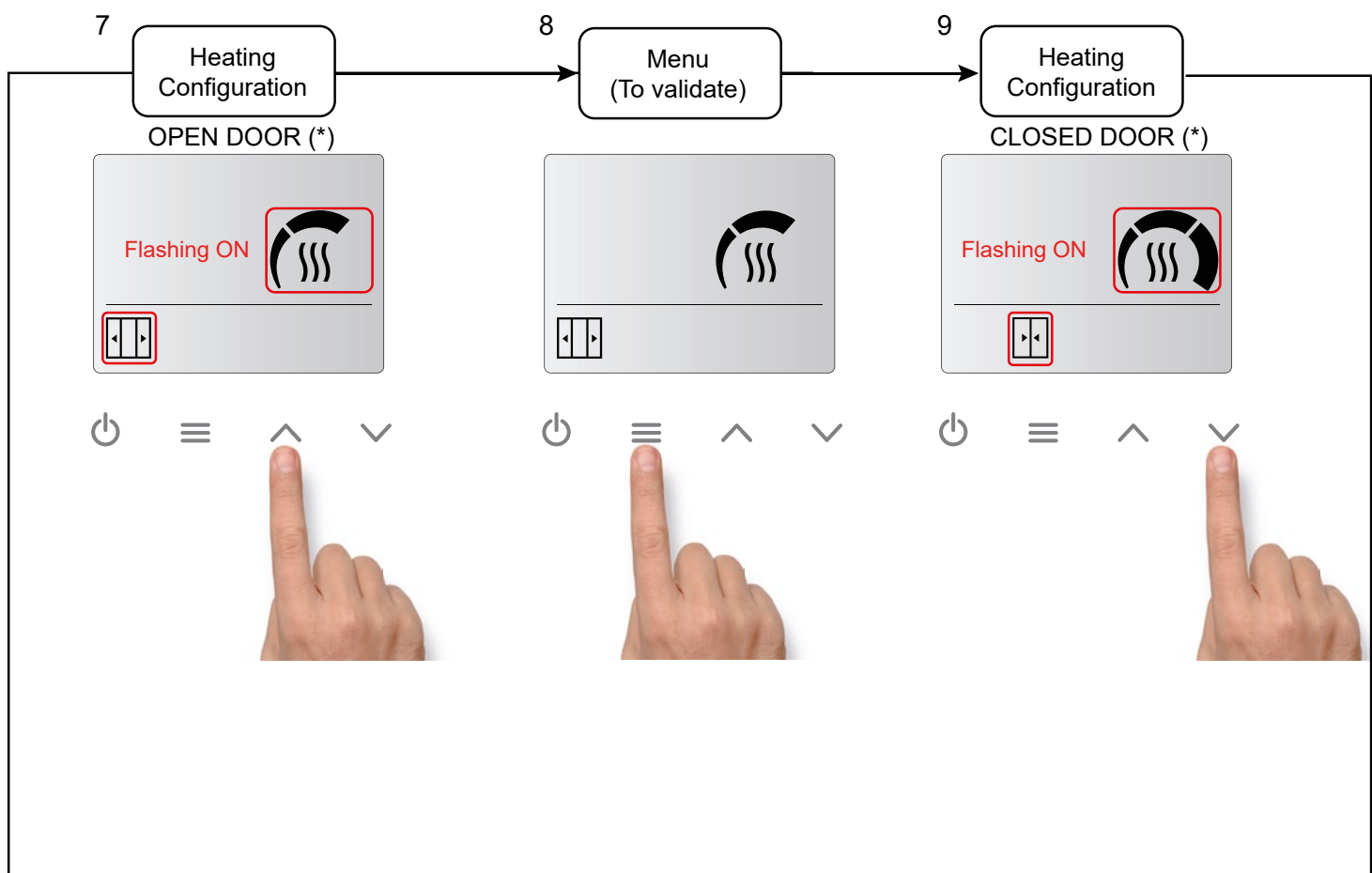

(*) If the door contact is not detected, the door open and door closed icons will not appear. Only one speed and one heating will be available.

Fast access for temperature setting (only for heated models):

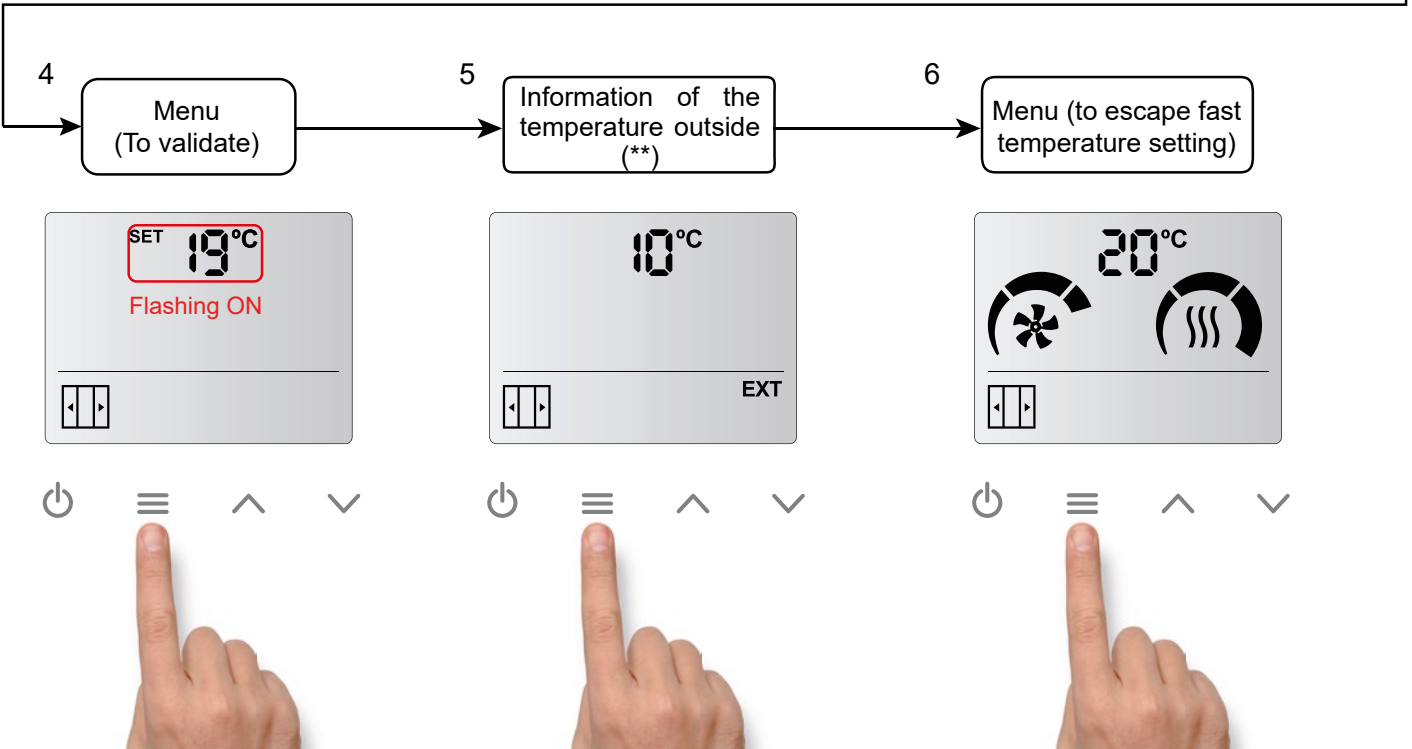
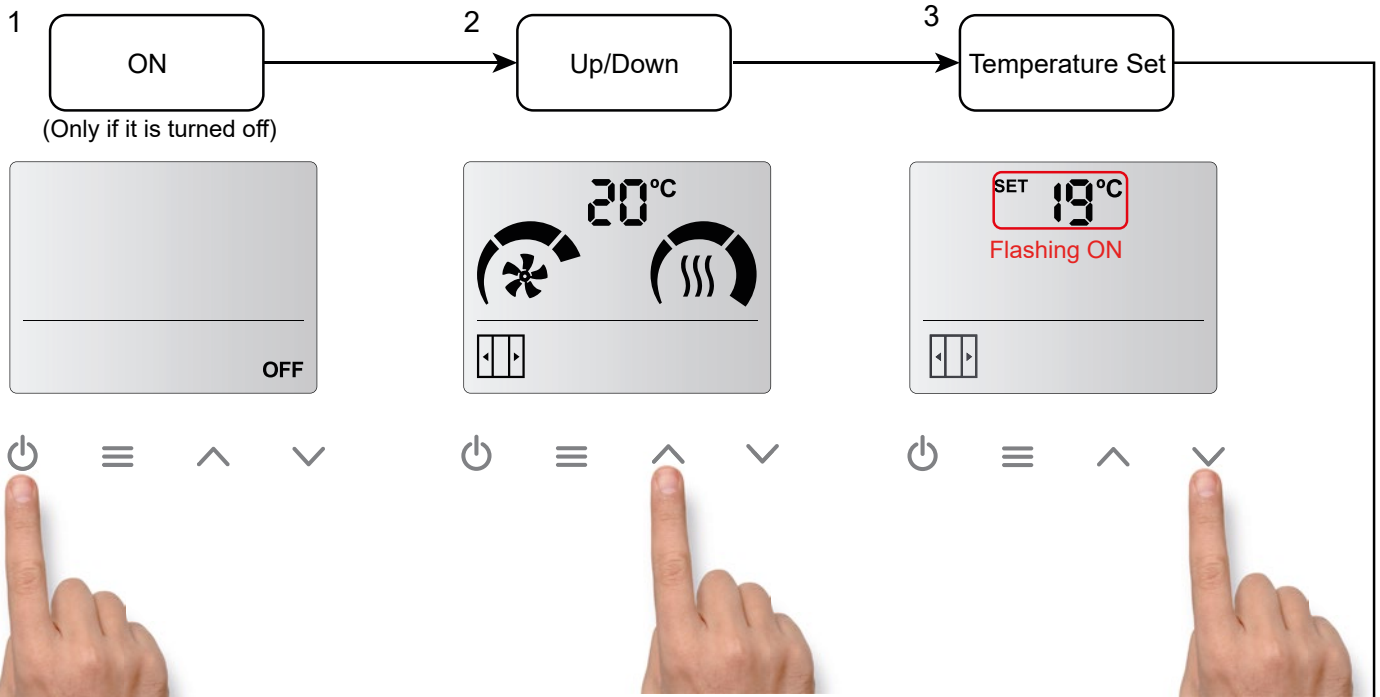

(**) Only if an outside temperature sensor is installed on the air curtain PCB.

Control Locking

The control can be locked, but the air curtain will still operate normally.
To lock the device, the user needs to press the following key combination:

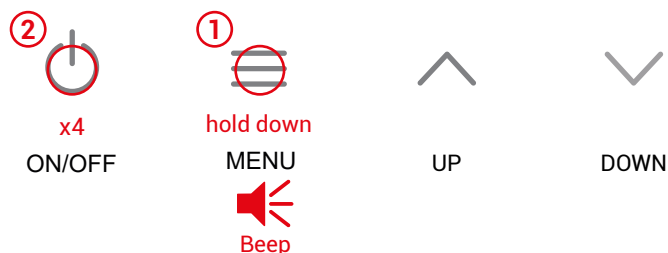

Hold down the menu button until the beep sounds and press the ON/OFF button 4 times and release the MENU button. Then it will be heard a higher-pitched beeping sound.

When the equipment is locked, we will not be able to carry out any action. This limitation also applies with the remote control.

For example, when pressing the menu, we will hear a lower-pitched beep indicating that the equipment is locked.

In addition, the alarm symbol shall appear on the display.

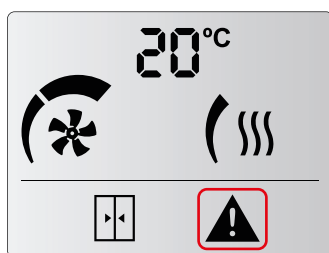

Flashing ON

To **unlock the unit**, the user must repeat the same combination of buttons as for locking.
Then it will be heard a higher-pitched beeping sound, indicating that the control has been unlocked.

Autocooling and external control

Autocooling:

Autocooling is only available for Electric heating only.

If the air curtain has been running with heating for more than 10 seconds at a time and the user switch it off, the ventilation continues ON (at the same speed before stop the control) up to a maximum of 90 seconds depending on the heating working time. The fan and speed stages icons will flash intermittently.

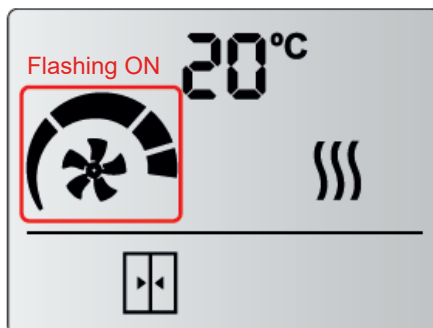

External control:

The "EXT" icon indicates that there is an external control to the unit and it is affecting the unit. There are two external signals available:

- **EXT OFF**: The unit has been stopped by External OFF contact. Not considered an alarm.
- **CALE OFF**: Heating OFF, stopped externally. Not considered an alarm.



EXT CONTROL OFF

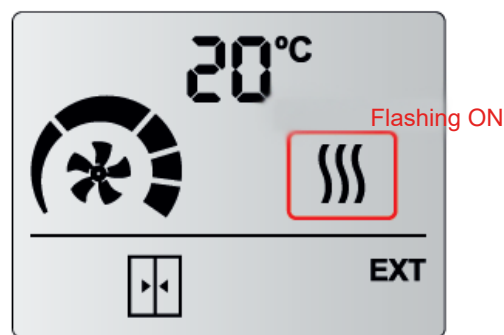

CALE OFF

Operation parameters menu

To access the advanced menu, hold down the menu button (until a beep is heard) then press the DOWN button 4 times and release the MENU button.

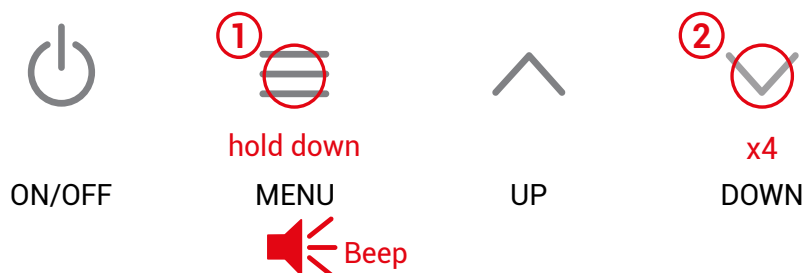

In this menu is possible to modify operation parameters of the air curtain like the door delay, the max speed and max heating with open or closed door, the frequency of filter maintenance, temperature units system used, memory or setting the boost mode.

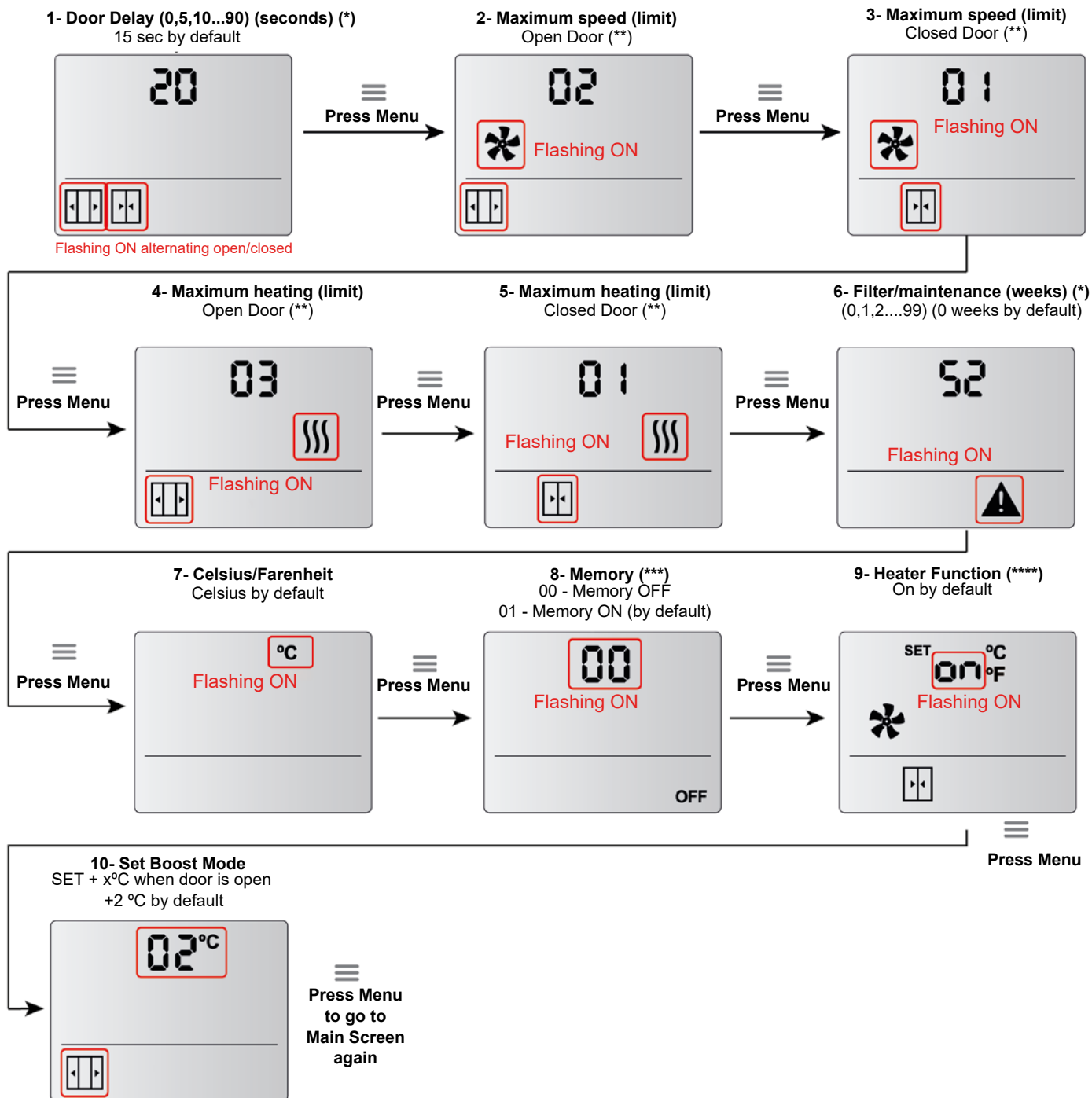

(*) The numbers are sequential. If the maximum is reached, it will go back to the beginning. For example, in the *Filter/maintenance weeks* when the user reach 99 in case to keep going up it will go back to 0.

(**) By default, door open/close icons are not activated. First time the door contact is closed, it is possible to choose door open heating/ventilation and door closed heating/ventilation.

(***) **Memory.** In a power failiure:

- If Memory is set as ON. Once power supply is restored, the unit will go back to work with the same parameters than before the failure.
- If Memory is set as OFF. The unit will remain switched off.

(****) **Heater Function.** Configurable Fan Status: When door is closed and room temperature is higher than SET temperature, fan can be set to continue ON and be ready for when the door is opened again, as an immediate protection. If function is set to OFF, the air curtain will stop if the same conditions are met.

Remote Control Features

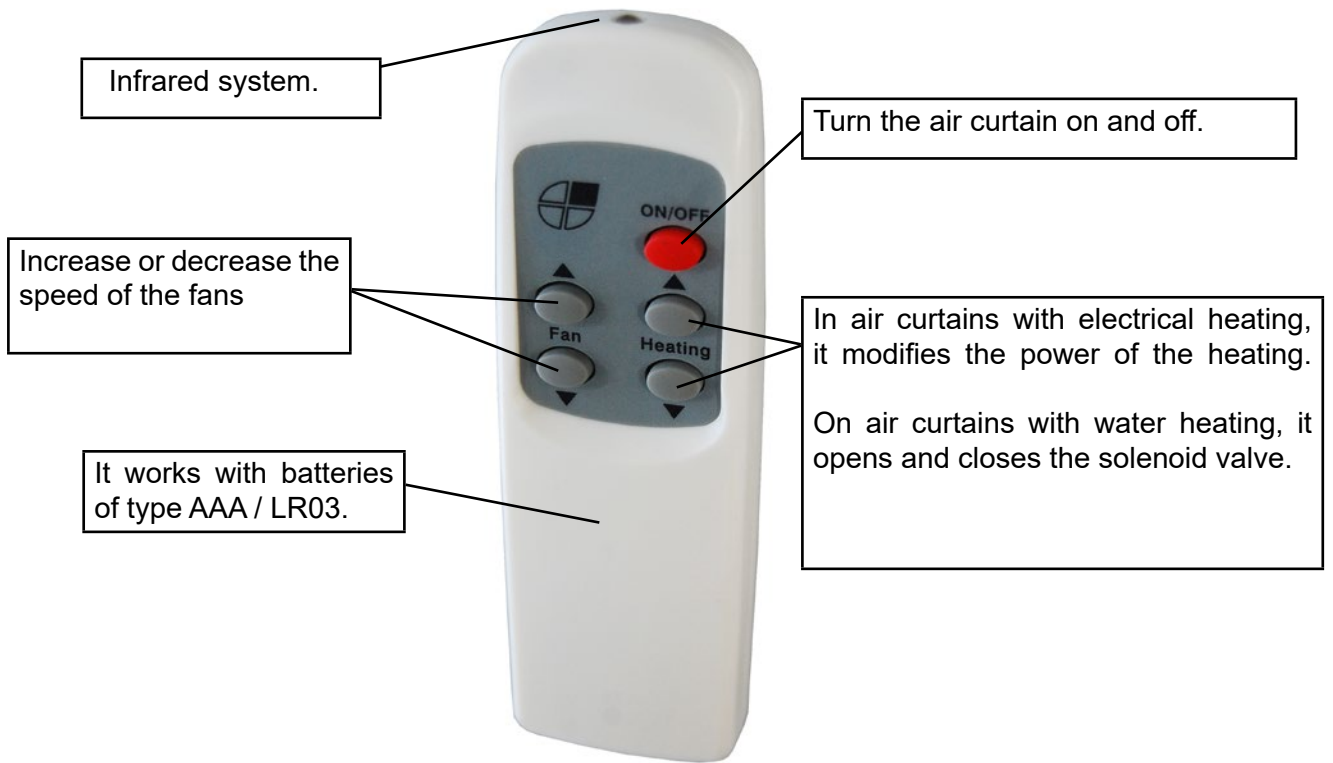

WIRING DIAGRAMS

Air curtain 2-speed with water coil or only air and **ADVANCED PRO** control Diagram AIRDOE08046

Control Optional inputs / Entradas Opcionales del Control	
Control	Closed / Cerrado =
D1 Off	= Curtain Off / Cortina Parada
D2 Heat off D2 Apagar Calefacción	= Heating Off / Calefacción Parada
D3 Fire Alarm D3 Alarma incendio	= Forced Off / Apagado Forzado

PCB Optional inputs / Entradas Opcionales de la PCB	
PCB	Closed / Cerrado =
Din1 Door	= Closed door / Puerta Cerrada
Din2 Off	= Curtain Off / Cortina Parada
TR Antifreezing / TR Anticongelación	= Antifreezing On / Anticongelación Activada

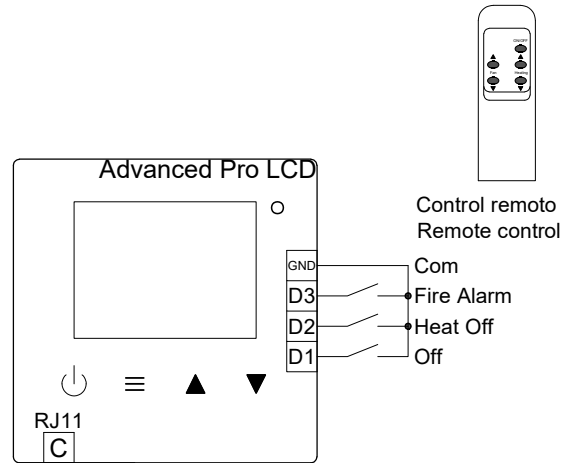

Q= Interruptor magnetotérmico
Q= Circuit breaker

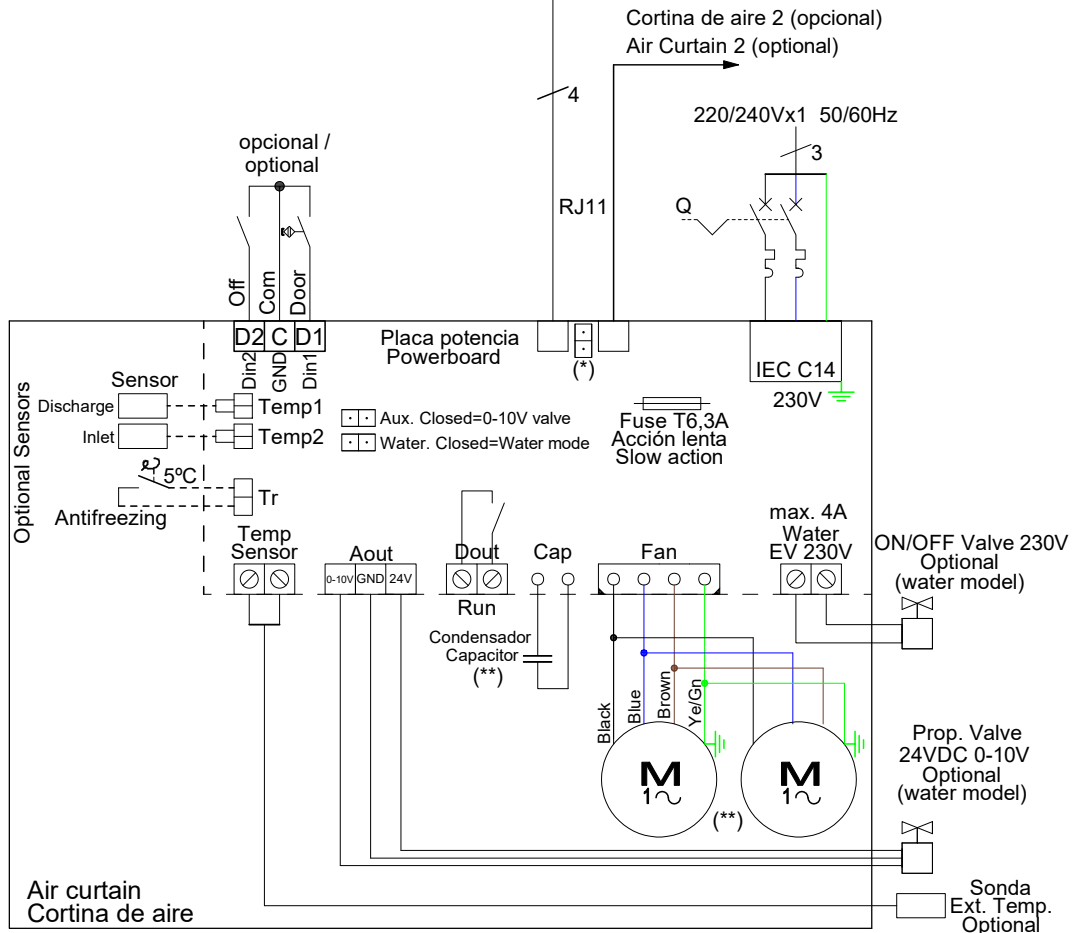

* When multiple air curtains are connected to an only control, the last one must incorporate a Jumper in "END LINE" pins.

* Cuando varias cortinas de aire estén conectadas a un sólo control, la última incorporará un puente en los bornes "END LINE".

**ARIS1000 50/60Hz = 1Fan45; 3 µF (60Hz 2,5µF)

**ARIS1500 50/60 Hz = 2Fan35; 5 µF

**ARIS2000 50/60Hz = 2Fan45; 6 µF (60Hz 5µF)

In case there is a need to connect the curtain to a PLC, the corresponding diagram is attached.

Air curtain 2-speed with electrical heater 400Vx3 and ADVANCED PRO control Model 1000 de 9kW Diagram AIRDOE08051

Control Optional inputs / Entradas Opcionales del Control	
Control	Closed / Cerrado =
D1 Off	= Curtain Off / Cortina Parada
D2 Heat off D2 Apagar Calefacción	= Heating Off / Calefacción Parada
D3 Fire Alarm D3 Alarma incendio	= Forced Off / Apagado Forzado

PCB Optional inputs / Entradas Opcionales de la PCB	
PCB	Closed / Cerrado =
Din1 Door	= Closed door / Puerta Cerrada
Din2 Off	= Curtain Off / Cortina Parada
TR Overheating TR Sobrecalentamiento	= Overheating On / Sobrecalentamiento Activado

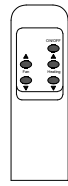
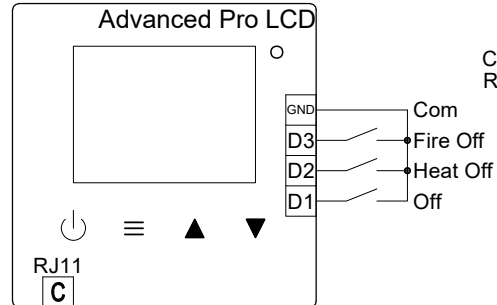

Control remoto
Remote control

Cortina de aire de 9kW; para 6kW no conectar L3; para 3kW no conectar L2 ni L3. Se puede limitar en el control 9kW Air Curtain; for 6kW don't connect L3; for 3kW don't connect L2 and L3. It can be limited from the control

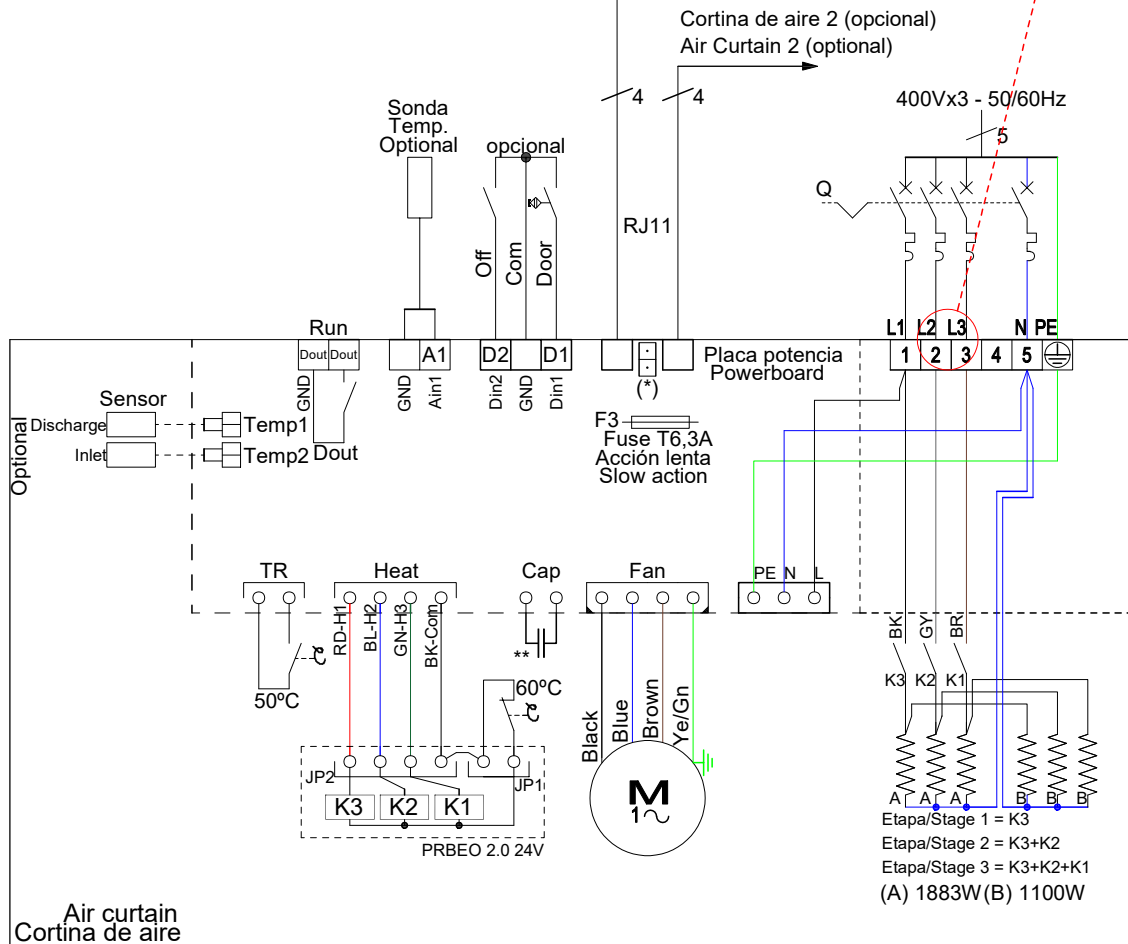

* When multiple air curtains are connected to an only control, the last one must incorporate a Jumper in "END LINE" pins.
 * Cuando varias cortinas de aire estén conectadas a un sólo control, la última incorporará un puente en los bornes "END LINE".
 **ARIS1000 50/60Hz = 1Fan45; 3 µF (60Hz 2,5µF)

In case there is a need to connect the curtain to a PLC, the corresponding diagram is attached.

Air curtain 2-speed with electrical heater 400Vx3 and ADVANCED PRO control Models 1500 12kW and 2000 18kW Diagram AIRDOE08056

Control Optional inputs / Entradas Opcionales del Control	
Control	Closed / Cerrado =
D1 Off	= Curtain Off / Cortina Parada
D2 Heat off	= Heating Off / Calefacción Parada
D2 Apagar Calefacción	
D3 Fire Alarm	= Forced Off / Apagado Forzado
D3 Alarma incendio	

PCB Optional inputs / Entradas Opcionales de la PCB	
PCB	Closed / Cerrado =
Din1 Door	= Closed door / Puerta Cerrada
Din2 Off	= Curtain Off / Cortina Parada
TR Overheating	= Overheating On / Sobrecalentamiento Activado
TR Sobrecalentamiento	

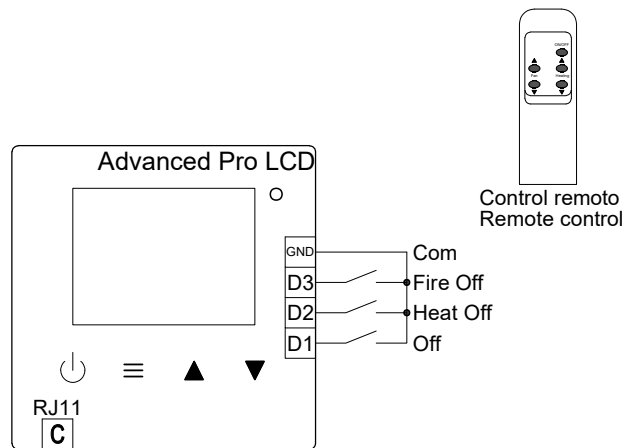

Cortina de aire de 12kW; para 6kW no conectar JP1 de la PRBEO2. Se puede limitar en el control 12kW Air Curtain; for 6kW don't connect JP1 from the PRBEO2; It can be limited from the control

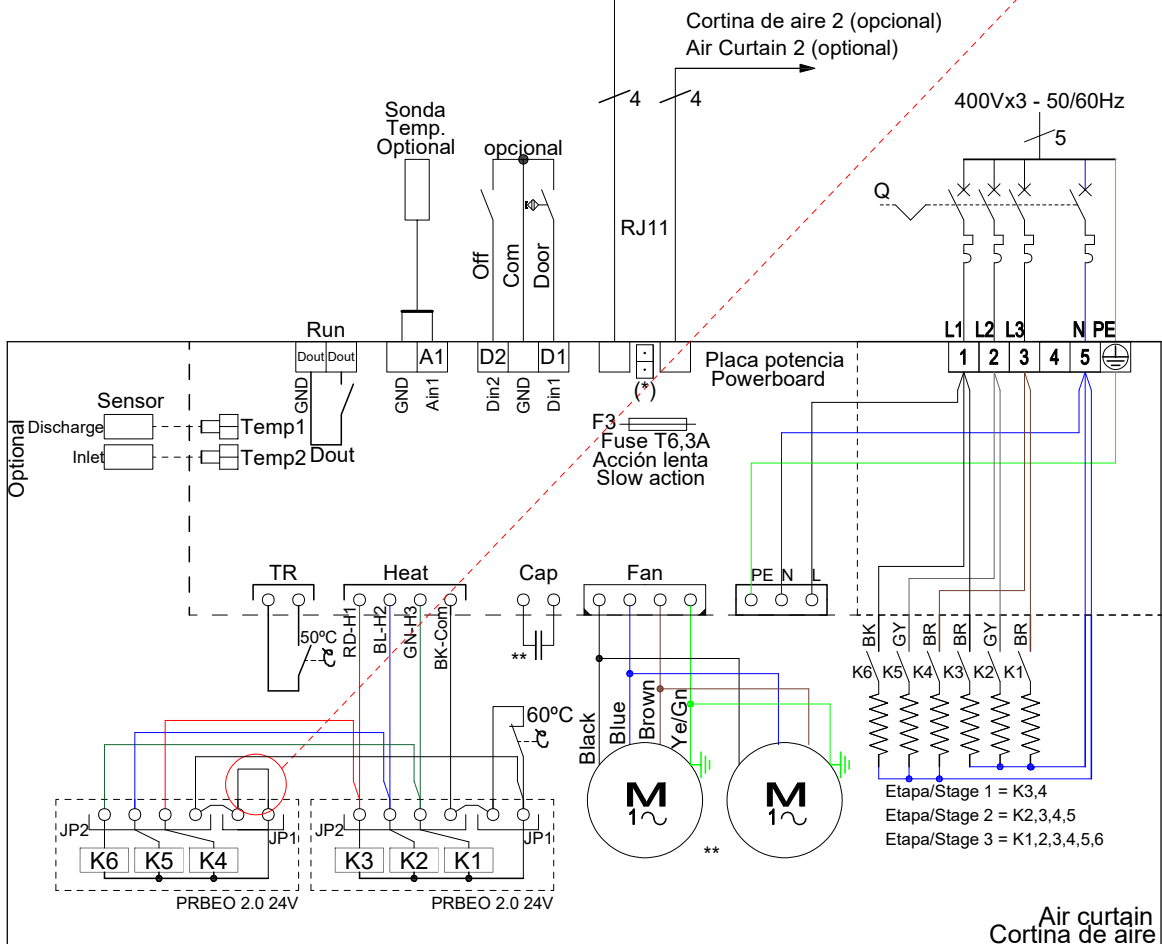

* When multiple air curtains are connected to an only control, the last one must incorporate a Jumper in "END LINE" pins.
 * Cuando varias cortinas de aire estén conectadas a un sólo control, la última incorporará un puente en los bornes "END LINE".
 **ARIS1500 50/60 Hz = 2Fan35; 5 µF
 **ARIS2000 50/60Hz = 2Fan45; 6 µF (60Hz 5µF)

In case there is a need to connect the curtain to a PLC, the corresponding diagram is attached.

DATASHEET

ARIS

STANDARD AIR CURTAINS
FOR COMMERCIAL DOORS

Technical Features



RAL 9016
standard



Other colors
on request



Range
Up to 3,5 m



Airflow / Length
1600 - 3600 m³/h
1 m to 2 m



Fan
Tangential
2-speed



Heating type
A : unheated
E : electrical 3 stages
P : water



Heating capacity
E : 3 - 18 kW
P : 7,27 - 19,34 kW



Control
Plug&Play Advanced PRO
+ IR remote control
(Optional Clever Pro Control)



Casing
Galvanised steel



Inlet grille
Rectangular perforated



Outlet lamellas
Aluminium, airfoil type

ARIS contemporary, discreet and elegant air curtain that features a smooth front panel with rounded edges and shapes, customizable with logos, lighting, signage or safety and informational signs. The inlet grille is hidden in the upper part, thus avoiding the internal vision of the air curtain. It incorporates tangential fans with low noise twisted profile turbine and 2-speed external rotor motor.

Advanced Plug&Play control. Includes: Advanced PRO control with LCD display and integrated thermostat, door contact, 7m RJ11 cable and remote control. Optional: intelligent Clever PRO Control (automatic, programmable, modbus for PLC, timer, etc).

❄ UNHEATED

Model	Airflow m³/h	Ventilation power 230V~50Hz W	Ventilation current 230V~50Hz A	Noise level (5 m) dB(A)	Weight kg
ARIS 1000 A	1900	123	0,59	37/52	20,5
ARIS 1500 A	2800	207	0,96	38/53	32
ARIS 2000 A	3800	253	1,18	39/54	39

⚡ ELECTRIC HEATED

Model	Airflow m³/h	Electrical heating capacity (*) kW	Power supply	Ventilation power 230V~50Hz W	Ventilation current 230V~50Hz A	Noise level (5 m) dB(A)	Weight kg
ARIS 1000 E	1800	3/6/9	400Vx3	131	0,59	37/52	24,5
ARIS 1500 E	2800	4/8/12	400Vx3	207	0,96	38/53	35
ARIS 2000 E	3600	6/12/18	400Vx3	253	1,18	39/54	50

(*) Under request other electrical heating power can be limited.

💧 WATER HEATED

Model	Airflow m³/h	P86 (80/60°C)		P64 (60/40°C)		Ventilation power 230V~50Hz W	Ventilation current 230V~50Hz A	Noise level (5 m) dB(A)	Weight kg
		Water heating capacity kW	Water pressure drop Pa	Water heating capacity kW	Water pressure drop Pa				
ARIS 1000 P86	1750	9,32	8980	-	-	116	0,53	39/53	23,5
ARIS 1000 P64	1600	-	-	7,27	8520	107	0,48	39/53	23,5
ARIS 1500 P86	2625	14,5	9150	-	-	187	0,86	40/54	34
ARIS 1500 P64	2350	-	-	11,15	8490	172	0,83	40/54	34
ARIS 2000 P86	3500	19,34	8490	-	-	222	1,03	41/55	43,5
ARIS 2000 P64	3200	-	-	15,08	8140	206	0,98	41/55	43,5

Water heated: connection pipes 1/2" female. P86 of 2 rows coil. P64 of 3 rows coil.

No model exceeds the 70dB of noise level.

Dimensions

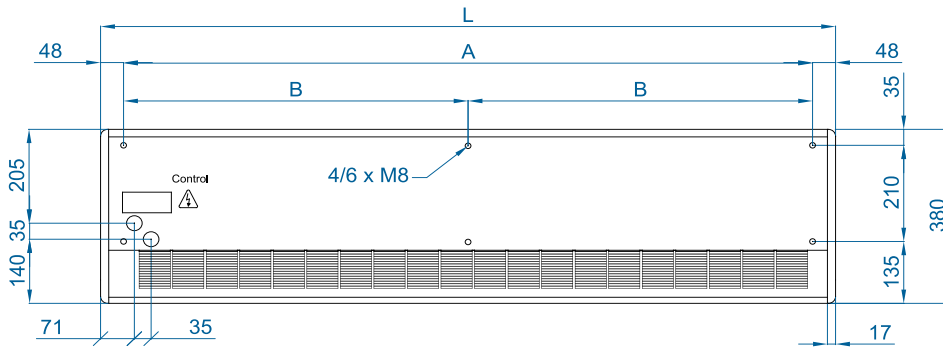

Smooth or customizable front panel with logos, lighting or signage

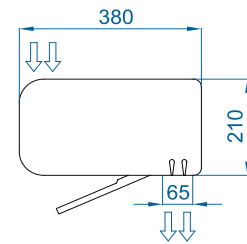
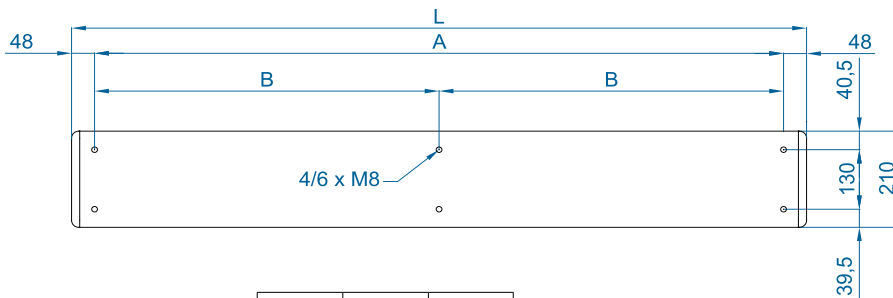

	L	A	B
ARIS 1000	1034	940	-
ARIS 1500	1534	1440	-
ARIS 2000	2034	1940	970



Selection program

CAD drawings, BIM files, installation manuals and other documentation



Optional accessories

Supports and installation



Wall rail support
SPWR



Silentblock supports
SPANG-SIL / SLB



Suspension cables
SPCT

Control



ADVANCED PRO
✓ Included



IR Control
✓ Included



RJ11 Cable
✓ Included



CLEVER PRO

Sensors and valves



Magnetic door contact
DC-MAG
✓ Included



Mechanical door contact
DC-MEC



External Temperature
Sensor



Solenoid valve
V-S (ON/OFF)



Proportional valve
V-ACT







Valve 3 ways
V-T



Anti-freezing sensor
AFS-INS

MAINTENANCE INSTRUCTIONS

	For safety, before cleaning, stop the air curtain through the control and after 10 minutes, disconnect the device from the current.
	For manipulation safety, being it assembling, transport or maintenance it's a must to wear the correct individual protection equipment recommended. Those being gloves, insulating shoes, goggles and helmet.
 	Do not open the service door (risk of electric shock and entrapment in the fans). Repairs must be carried out exclusively by authorized personnel.
	The inside of the device must not be cleaned with water or steam.

Indicative periodicity of maintenance

N° Action	Action	Frequency
1	Cleaning of the suction grille	Bimonthly (recommended monthly)
2	Exterior cleaning	Semiannual (recommended quarterly)
3	Interior cleaning	Semiannual (recommended quarterly)
4	Internal inspection	Biannual (recommended annual)
5	Consumption and auditory control	Biannual (recommended annual)
6	Water heating maintenance	Semiannual (recommended quarterly)
7	Electrical heating maintenance	Semiannual (recommended quarterly)

Suction grille cleaning

The suction grille prevents the entry of objects into the internal elements. It is highly recommended to check that the suction grille is free of any object that could prevent air from entering (plastic bags, paper, etc.). It is recommended to clean the suction grille monthly. In addition, it is important to make sure that the air curtain is off, otherwise the mixture between the dust and a damp cloth would form a paste of dirt that could damage the fan rotor when it sucks in the air or clog the water battery.

An annual cleaning of the discharge area must be carried out.

It is advisable to do it frequently (depending on the dirt generated) since performance is considerably reduced.



Exterior cleaning

Wipe the entire outer surface of the air curtain (except the suction grille) with a damp cloth to trap dust particles. In addition to the damp cloth, neutral soaps that do not contain acids or are caustic can be used.



Interior cleaning

It is recommended to clean the inside of the unit with a vacuum cleaner at least once every 2 years. (*) It is recommended to clean the inside of the equipment frequently with the help of a vacuum cleaner, especially before the arrival of winter. (*)

(*) These periods are indicative depending on the conditions of each installation. In places with a high number of suspended particles, it is desirable to increase the frequency of interior cleaning.



Internal components visual inspection

Check that the regulation board have not suffered any damage and that they are securely fastened to the equipment frame. Make sure that the board and internal wiring connectors are still well connected. Check that the motors do not move from their mountings and check that the turbines have no impediments to rotate freely (turn it by hand, first turn off the device).

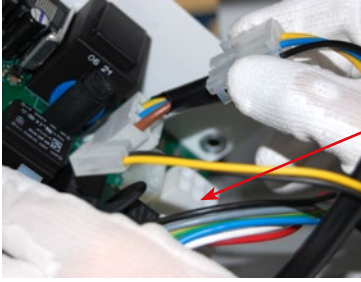

Air curtain consumption and auditory control checking

Write down the consumption value of the fans that appears on the product label (located on the inside of the service door). Close the door, give power supply to the air curtain and with the help of an ammeter, check that the electrical consumption of the air curtain at maximum speed is between 110% and 85% of the value indicated on the label. Check that all fans blow air. Keep the air curtain at full speed for a few minutes and listen for abnormal noises from the air curtain.



Heating maintenance

To ensure good heat transmission in the air curtain exchanger, it is recommended to check the battery as follows:

Battery cleaning

With both electric battery and water battery, must be cleaned periodically with pressurized air.



Water Heating

Check the inlets and outlets of the water tubes to ensure that there are no fluid leaks.



If a water leak has been detected in the battery, possible corrosion problems in both the battery and the air curtain components should be checked.

Electrical heat

Check that no cable has been disconnected from the battery circuit:



Resistance type for Aris models in all their lengths

To verify the correct operation of the component, check the battery consumption per heating stage. Theoretical consumptions are shown below:





Air Curtain Models	Heating Stage	Power by stage (kW)	Theoretical consumption (A) 400Vx3		
			L1	L2	L3
1000 9kW	1	3	13	0	0
	2	6	13	13	0
	3	9	13	13	13
1500 12kW	1	4	8,7	0	8,7
	2	8	8,7	17,4	8,7
	3	12	17,4	17,4	17,4
2000 18KW	1	6	13	0	13
	2	12	13	26,1	13
	3	18	26,1	26,1	26,1



REPAIRS AND REPLACEMENTS

Assembly and electrical connection must be carried out exclusively by specialized professionals and in compliance with these instructions.

Before carrying out any repair, it is necessary to:

	<ul style="list-style-type: none"> • Notify staff and indicate that work is being done. • Disconnect the current and protect the circuit breaker.
	<ul style="list-style-type: none"> • Be sure there is no voltage in the unit.
	<ul style="list-style-type: none"> • Be sure the fans have stopped. • Use only original spare parts.
	<p>For manipulation safety, being it assembling, transport or maintenance duties it's a must to wear the correct individual protection equipment recommended. Those being gloves, insulating shoes, goggles and helmet.</p>



CODE	COMPONENT	COMPONENT REFERENCE	CURTAIN MODEL
ELACCO33005	ADVANCED PRO LCD 2 & 5 speeds	CON-LCD	Aris 1000, 1500 and 2000
ECOCME06045	External rotor motor	4REC35 62Z X22-05	Aris 1500
ECOCME06085	External rotor motor	4RET45-55S Y18-03	Aris 1000 and 2000
ECOCME06046	External rotor motor	4REC35 J10-A0	Aris 1500
ECOCME06083	External rotor motor	4RET45-55S Y47-A0	Aris 2000
VSACCO33005	PCB Air/water 2 speed	PCB-2SO-AIR/WAT	Aris: Air/Water
VSACCO33010	PCB Electrical 2 speed	PCB-2SO-ELE	Aris: Electrical

Service door opening

Aris model

1. Gently pull between the grille and the door with a flathead screwdriver and open the service door with both hands.

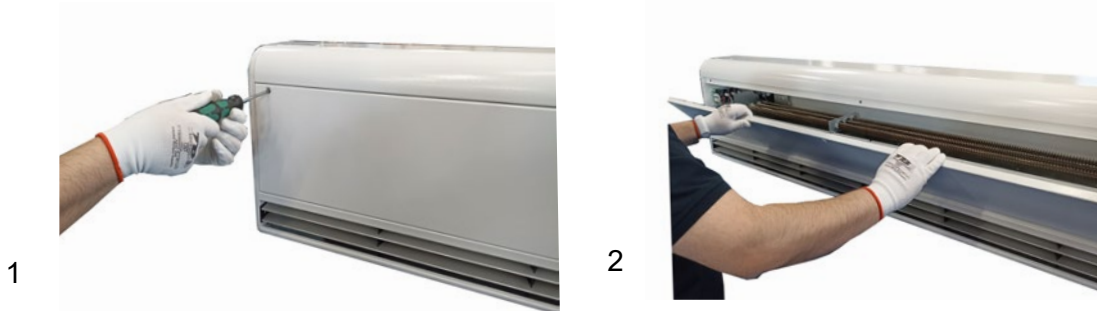

Motor replacement

Before changing the power board or fuse, notify and indicate that work is being done, disconnect the power supply, make sure that there is no voltage and that the machine has stopped.

Next, remove the lateral panels as shown before, open the grille, identify and release the motor cables. Remove the lateral (4 screws), unscrew the motor, unscrew the turbine from the shaft and mount the replacement motor following the process in reverse order.

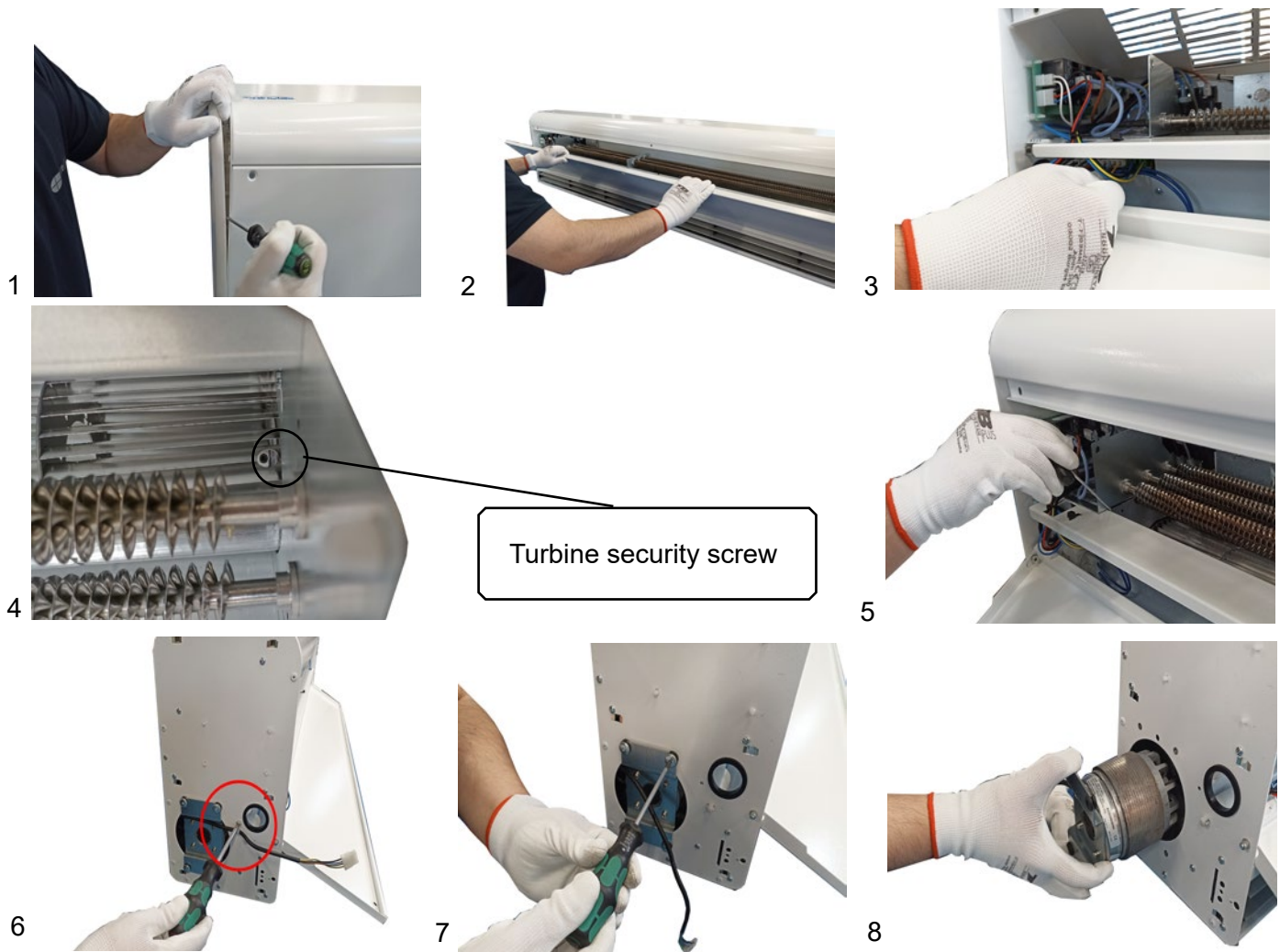

Fuse or PCB replacement

Before changing the power board or fuse, notify and indicate that work is being done, disconnect the power supply, make sure that there is no voltage and that the fans have stopped. **Change power board:** open the service door and disconnect the cables from the PCB. Remove the power plate loosening screws from outside of the air curtain to remove the plate and carry out the necessary repair.

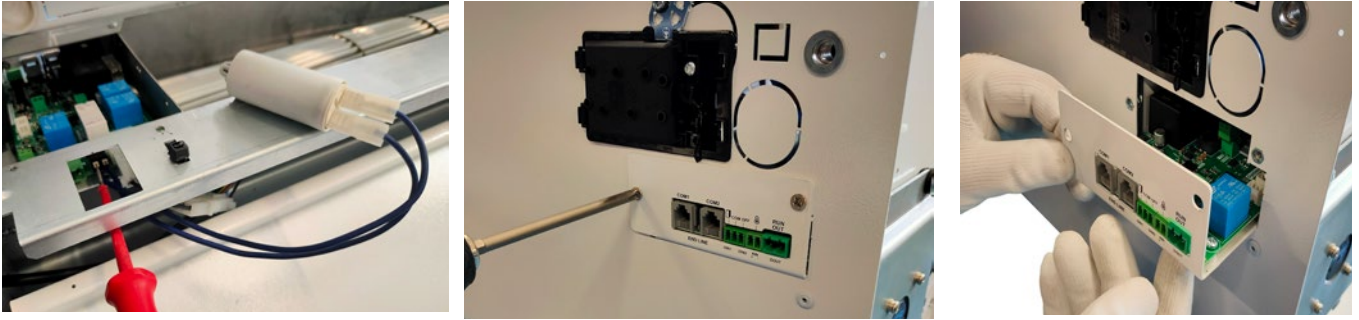

Change fuse: remove the pcb from the air curtain for better maneuverability, remove the fuse protection casing and remove the fuse by hand or with the help of a screwdriver. Proceed to install the replacement and follow the reverse process to leave the curtain functional.



Recommendation: installation with silentblocks

To reduce the sound level and the vibrations of the air curtain, it is recommended to carry out an installation with silentblocks:



Water heating replacement

Warning! The curtain is not designed to operate in cold mode. Do not circulate cold water through the battery.

Before changing the battery, warn and indicate that work is in progress, disconnect the power supply, make sure that there is no voltage and that the fans have stopped.

1. Close the building's water inlet and outlet valves up to the air curtain.
2. Remove the screws from the service door and open it with both hands.



3. Remove the suction grille, unscrew the screws that hold water coils battery to the air curtain housing.

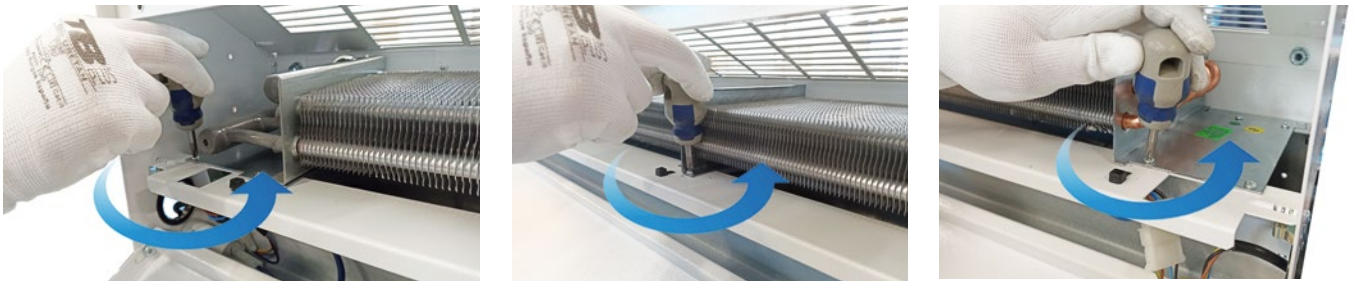

4. Drain the water battery with the drain plug of the main collector as shown in the picture and disconnect the battery from the installation.
5. Remove the battery from the air curtain housing.



Electrical heating replacement

Disconnect the power supply from the battery. To do this, remove the black connection box from the air curtain housing.



To remove the battery, remove the suction grille (process shown in water battery). Unscrew the fixing screws (see table at the bottom of the page to count the screws to be removed), disconnect the PRBEO cables from both parts of the battery and remove the battery with both hands.



Air curtain size	N° battery fixing screws
1000	4
1500	6
2000	6

TROUBLESHOOTING

More than 95% of the claims occur **during the start-up** of the equipment and **are due to installation errors**. Reviewing the following points solves more than 90% of the incidents:



A) RJ11 cable manipulated: the cable connecting the control to the air curtain is a 4-way RJ11 cable. If it is manipulated (cut or remove the connector) and spliced backwards, the shade will not work properly and may also damage the electronics. Only re-splicing the connector correctly solves the problem (connection diagram).

B) Incorrect power supply. The supply of the air curtain depends on the type of current available and the type of heating of the equipment. Check bounding jumper if required, according to the wiring diagram.

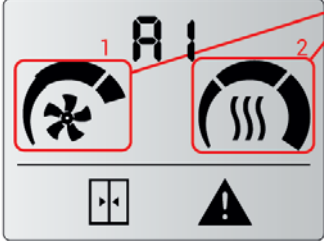
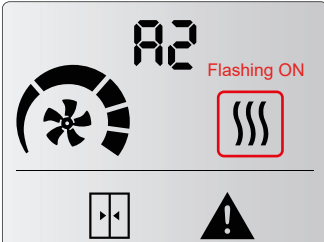
Most commons problems and solutions		
Symptom	Problem	Solution
No light on LCD control	Is the RJ11 cable the original without splices or shortening?	Change the cable or reconnect it correctly.
	Does the current reach the connection box?	Correctly connect the terminals of the connection box: Between L and N there must be 230V. If the curtain has a three-phase electric battery, there must be 400V between terminals L1, L2 and L3.
	Is the fuse on the board in good condition?	Check the fuse and change it if necessary (type T, slow action 6,3A).
The heating does not work	Does the three-phase current reach the connection box?	Check installation.

Alarms Lists		
Comment	Problem and Alert	Solution
Alarms will remain fixed on the display because it affects to the device functioning. Some lights on the remote control flash and an alert sign will appear in the display. Alarms will be shown as an "A" followed by a number to indicate the code of the alarm.	Overheating (only electrical heated) (A1) 	When the unit goes into overheating, it starts a process to cool it down. The ventilation starts to rise up to the maximum each 2 minutes. If overheating persists, the heating is turned down each 2 minutes until it is switched off. If it is still not solved, after 2 minutes heating is blocked and alarm A2 is activated (check A2).
	Heating blocked (only electrical heated) (A2) 	The heating is blocked and switched off. It is the overheating safety program. Service must check the unit and fix the problem to avoid internal damages. Once solved, reset the unit.

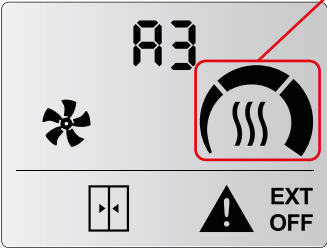
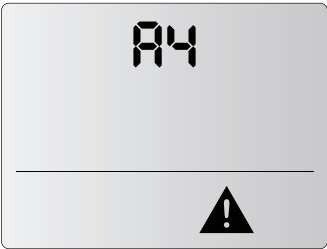
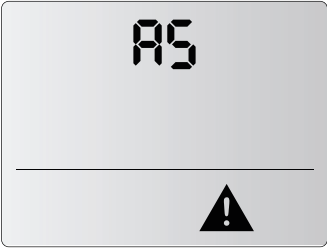
Alarms Lists

Comment	Problem and Alert	Solution
<p>Alarms will remain fixed on the display because it affects to the device functioning. Some lights on the remote control flash and an alert sign will appear in the display. Alarms will be shown as an "A" followed by a number to indicate the code of the alarm.</p>	<p>Antifreezing (only water heated) (A3)</p> 	<p>When ambient temperature is below anti-freezing temperature set (5°C), the valve opens to protect the water coil and the fan stops functioning. It can be also activated by external anti-freezing sensor connected to the PCB or a discharge temperature sensor installed on the air curtain PCB.</p>
	<p>Communications error (A4)</p> 	<p>No unit found.</p>
	<p>Inappropriate device (A5)</p> 	<p>Wrong combination of 2 different heatings (electric with water or heat pump) It is only possible to mix unheated units with one type of heating units.</p>
	<p>Fire Alarm (A6)</p> 	<p>Stops and locks the unit. To unlock it, the power supply must be switched off. It is activated with DIN3 digital IN on the control unit.</p>

Error Lists

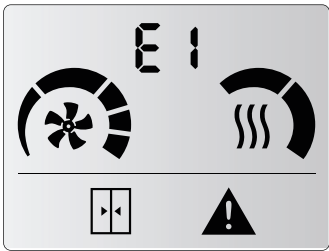
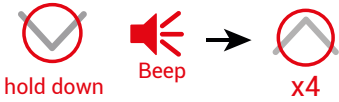
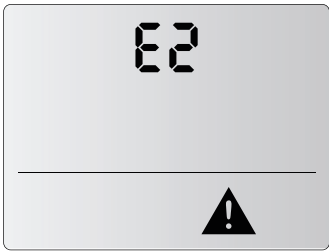
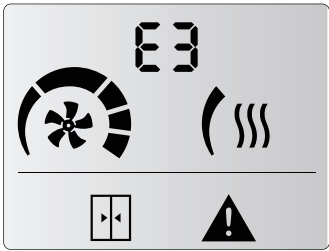
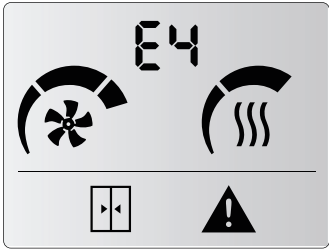
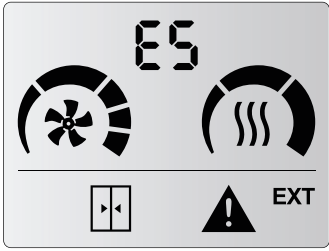
Comment	Problem	Solution
<p>Errors will not remain on the display, they will alternate with the ambient temperature. Unit operation remains working normal or adapted. Some lights on the remote control flash and an alert sign will appear in the display. Errors will be shown as an "E" followed by a number to indicate the code of the error.</p>	<p>Filter/maintenance (E1)</p> 	<p>Indicates filter change or cleaning / maintenance. This alarm is activated by time counter. It does not affect operation. To reset the counter:</p>  <p style="text-align: center;">hold down Beep → x4</p>
	<p>Missing device (E2)</p> 	<p>One of the working units is not found. Please consult service to check the unit. To reset, turn OFF power. Other devices remains working normal.</p>
	<p>Missing temperature sensor (E3)</p> 	<p>Missing temperature sensor or temperature out of range. Unit operation adapts and remains working according to inbuilt room temperature sensor.</p>
	<p>Fan Error (E4)</p> 	<p>Some fan has stopped. Check the unit. Unit operation remains normal. Not available in 2-speed range.</p>
	<p>External Alarm (E5)</p> 	<p>Indicates an external alarm. Unit operation remains normal. Only programmable with CLEVER PRO control (consult CLEVER PRO Manual).</p>

DECLARATION OF CONFORMITY



Declaration **CE** of conformity / Declaración **CE** de conformidad

Manufacturer **Motors i Ventiladors S.L. (AIRTÈCNICS)**
Fabricante **Conca de Barberà 6, Pol. Ind. Pla de la Bruguera**
08211 Castellar del Vallès (Barcelona) Spain

We declare, under our sole responsibility, that the product
Declaramos, bajo nuestra única responsabilidad, que el producto

Air Curtains
Cortinas de aire

with models / *con los modelos*

Minibel, Optima, Recessed Optima, Optima Wireless, Recessed Optima Wireless, Optima K, Optima Switch, Recessed Optima Switch, Top, Recessed Compact, Aris, Windbox, Recessed Windbox, Smart, Dam, Recessed Dam, Deco, Kool, Rund, Invisair, Rotowind, Variwind, Zen, Max, Maxwell, Compact Fly, Fly K, Fly KL-KXL, Fly KBB, Windbox BB, Recessed Windbox BB, Zen BB, Invisair BB, Kool BB, Rotowind BB, Zen L-XL, Windbox L-XL, Duojet, Triojet System

is/are developed, designed and manufactured in accordance with the following directive(s)
ha(n) sido desarrollado(s), diseñado(s) y fabricado(s) de acuerdo con la(s) siguiente(s) directiva(s)

Low Voltage Directive 2014/35/EU
Directiva Baja Tensión 2014/35/UE

Electromagnetic Compatibility Directive 2014/30/EU
Directiva Compatibilidad Electromagnética 2014/30/UE

Restriction Certain Hazardous Substances Directive 2011/65/EU (RoHS)
Directiva Restricción Substancias Peligrosas 2011/65/UE

Eco-design Energy-related Products Directive 2009/125/EC
Directiva Diseño Ecológico Productos Con Energía 2009/125/CE

applying the following harmonized standards in particular
aplicando las siguientes normas armonizadas en particular

LVD: EN 60335-1:2012 + AC:2014 + A11:2014 + A13:2017 + A1:2019 + A:14:2019 + A2:2019
EN 60335-2-30:2009 + A11:2012 + A1:2020 + A12:2020

EMC: EN 61000-3-11:2000
EN 61000-3-12:2011
EN 55014-1:2017 + A11:2020
EN 55014-2:2015
EN 62233:2008 + AC:2008

RoHS: EN 50581:2012

Date / Fecha
Name / Nombre
Position / Cargo

04/03/2024
Jordi Hierro
Technical Manager / Director Técnico

MOTORS I VENTILADORS, S.L.
ESB58967183 - C/ Conca de Barberà, 6
08211 Castellar del Vallès
Tel. 937159988 - Fax 937159989

UK
CA

UK Declaration of conformity

Manufacturer **Motors i Ventiladors S.L. (AIRTÈCNICS)**
Conca de Barberà 6, Pol. Ind. Pla de la Bruguera
08211 Castellar del Vallès (Barcelona) Spain

We declare, under our sole responsibility, that the product

Air Curtains

with models

Minibel, Optima, Optima Swith, Recessed Optima, Optima Wireless, Recessed Optima Wireless, Optima K, Top, Recessed Compact, Aris, Windbox, Recessed Windbox, Smart, Dam, Recessed Dam, Deco, Kool, Rund, Invisair, Rotowind, Variwind, Zen, Max, Maxwell, Compact Fly, Fly K, Fly KL-KXL, Fly KBB, Windbox BB, Recessed Windbox BB, Zen BB, Windbox L-XL, Duojet, Triojet System.

is/are developed, designed and manufactured in accordance with the following regulation(s)

Electrical Equipment (Safety) Regulations 2016 No. 1101

Electromagnetic Compatibility Regulations 2016 No. 1091

The Restriction of the Use of Certain Hazardous Substances in Electrical and Electronic Equipment Regulations 2012 No. 3032

The Ecodesign for Energy-Related Products and Energy Information (Amendment) (EU Exit) Regulations 2019 No. 539

applying the following harmonized standards in particular

**LVD: BS EN 60335-1:2012+A2:2019
BS EN 60335-2-30:2009+A12:2020**

**EMC: BS EN IEC 61000-3-11:2019
BS EN 61000-3-12:2011
BS EN IEC 55014-1:2021
BS EN IEC 55014-2:2021**

RoHS: BS EN IEC 63000:2018

Date
Name
Position

16/10/2023
Jordi Hierro
Technical Manager



MOTORS I VENTILADORS, S.L.
ESB58967183 - C/ Conca de Barberà, 6
08211 Castellar del Vallès
Tel. 937159988 - Fax 937159989

IDENTIFICATOR



Model <small>Modelo</small>	WINDBOX M 2000 P86		
Airflow <small>Caudal</small>	3320	m3/h	
Blowers <small>Ventiladores</small>	3,8 A	0,856 kW	230 V/50Hz
Heating			
<small>Calefacción</small>	<small>Temperatura</small>	<small>Capacity</small>	<small>Water Flow</small>
<small>Bateria Agua</small>	80/60 °C	20,65 kW	900 l/h
<small>Bateria Eléctrica</small>	Electric Heater kW		
Serial Number <small>Número de Serie</small>	2022 01 21 / 113.864		

Each air curtain is identified by a unique serial number printed in a label located inside the door service. There is also indicated the model and their technical characteristics (flow, fans technical characteristics and power heating).

It is indispensable to have this number to facilitate possible replacements or technical information of the air curtain in question.



AIRCOR15698 113864

WINDBOX M 2000 P86 www.airtecnics.com

GUARANTEE

Your air curtain is guaranteed for a period of two years from the date of purchase. We will adjust, repair or replace at our discretion from our warehouse any defect, system failure or part found to be defective. The assembly cost out of our warehouse is at buyer expense. The products that, in our eyes, have been inadequately used, incorrectly manipulated, improperly installed, connected to different nominal tensions, modified, repaired by non-authorized workers or that have suffered damages during transport are totally excluded from the guarantee.

To validate the guarantee it should be correctly filled and enclosed with the invoice that vouches for the buying date. If it is manipulated, it will lose all validity.

It is the buyer's responsibility to take the necessary safety measures because in case of a failure or mistake in one of our products, no damages to third parties, sets or installations will occur.

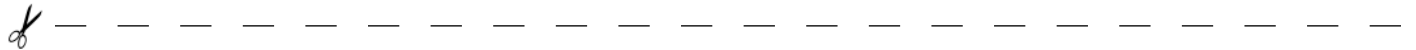

Guarantee draft

Air curtains data:

Model: Series number:

Invoice date:..... Invoice number:

Buyer data:

Name:

Address:

Country: Phone: Mail:.....

Seller data:

Name:

Address

Country: Phone: Mail:.....

Buyer signature and stamp

Seller signature and stamp



If you detect some error in this manual, we'll be pleased to receive your feedback, it helps us to improve even more. Airtècnics reserves the right to modify some of the specifications in this manual

Conca de Barberà, 6 - Pol. Ind. Pla de la Bruguera
E-08211 Castellar del Vallès (Barcelona) Spain
☎ + 34 93 715 99 88
airtecnicos@airtecnicos.com

www.airtecnicos.com